

# NUMATICS®

## S Series

Stainless Steel NFPA Interchangeable Cylinder Line

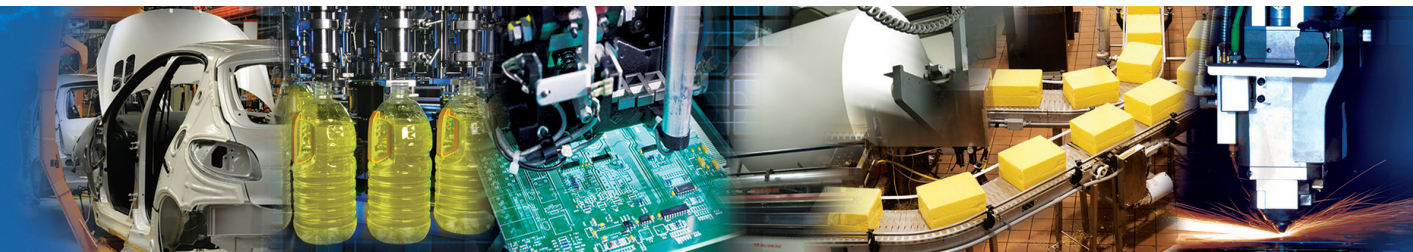

[www.numatics.com](http://www.numatics.com)

## S Series

Features and Benefits	3
Standard Mounts	4
How to Order	5
Loading and Cushioning	6
Optional Features	7
Dimensions	8-14
Basic No-Mount	8
Rod Ends	9
Flange Mounts	10
Bottom Tap and Clevis Mount	11
Extended Tie Rod Mounts	12
Trunnion Mounts	13
Double Rod End	14
Accessories-Stainless Steel	15
Couplers	16
World Switches	17-18
NFPA Interchangeable Cylinders	18
Sensing Part Numbers	19-21
Quick Disconnect Cables	22
How to Order - S Series Piston Rod Assembly	23
How to Order - S Series Repair Kit	24
How to Order - S Series Seal Kit	24
Piston Rod Assembly Kit Removal/Installation Instructions	25
Repair and Seal Kit Removal/Installation Instructions	25
Diagrams	26
Seal Installation Guide	27

The **S Series** is a stainless steel NFPA Interchangeable pneumatic cylinder line. It is designed and built to perform in the toughest “wash down” applications. The stainless steel construction provides outstanding corrosion resistance while including a multitude of favorable design features. The S Series encompasses many of the same proven design features as our original NFPA Interchangeable cylinder, the A Series. This includes an extra long bushing and a standard oversized wear band located on the rear of the piston. Additionally, we have also included the proven T Seal piston seal configuration with carboxilated nitrile with self-lubricating PTFE compound. These are just a few of the features that make the S Series the Superior Stainless Steel NFPA Interchangeable air cylinder line.

### Tube

The 316 stainless steel **tube** provides smooth, corrosion free operation.

### End Caps

The **end caps** are accurately machined from precision 316 stainless steel blocks. Additionally, a recess on the piston-mating surface (at both ends) enables the air to work on a larger piston area for effortless breakthrough.

### Rod Bushing

The S Series includes a cutting edge PolyLube™ composite **rod bushing** that is extra long in length. The composite rod bushing is specifically designed for applications where corrosion, low friction, and excellent wear characteristics are desired.

### Rod Seal

The carboxilated nitrile with PTFE compound **rod seal** is self-lubricating and durable. The rounded lip design ensures proper sealing and long life.

### Rod Wiper

The standard **rod wiper** construction is a highly durable polyurethane.

### Piston Rod

The **piston rod** is machined from 303 stainless steel and is turned, ground, polished, and has a chrome plated surface. This surface provides maximum life for both the rod bushing and the seals.

### Bushing Retainer

The **bushing retainer** is machined from highly corrosion resistant 304 stainless steel bar stock. Additionally, it is a full-face design. This is to minimize corners and crevices. It enables the cylinder to perform in food grade applications.

### Tie Rods

The **tie rods** are drawn and ground 303 high strength stainless steel. The tie rod threads are rolled for superior strength and engagement. Furthermore, the tie rods are secured with 304 stainless steel acorn nuts. This eliminates exposed threads. Again, enabling the S Series cylinder to perform in food grade application.

### Piston Seal

The **piston seal** is a carboxilated nitrile with PTFE compound for self-lubrication. The “T” seal with back-up ring construction prevents rolling and seals at all pressures.

### Wear Band

The **wear band** is a stable, lubricating strip located on the piston. We separated the load bearing points by locating the wear band at the rear of the piston. This maximizes column strength at full extension.

### Piston

The solid aluminum alloy **piston** is strong and durable.

### Cushion Seal

The floating **cushion seal** design enables rapid stroke reversal by providing instantaneous full flow to the piston. Each cushion has a flush, retained adjustment needle.

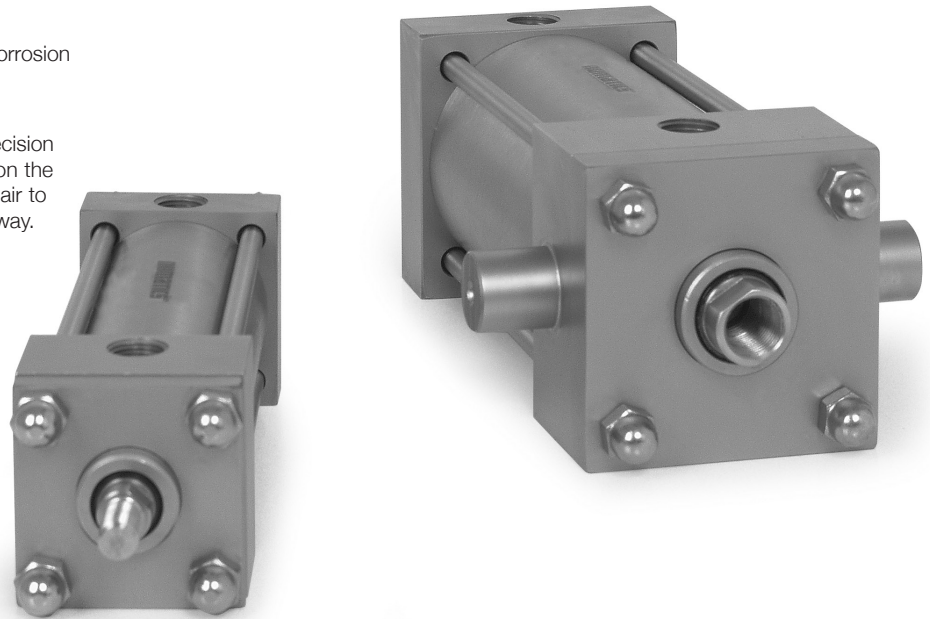

### Tube End Seal

The **tube end seals** are compression type and reusable.

### Ports

Our enhanced **port** design enables the cylinder to work more efficiently. Through the use of precise machining depths and tool shape, we are able to smooth the flow path into and out of the cylinder.

## Standard Specifications:

- Meets NFPA specifications
- Bore sizes from 1-1/2" through 8"
- Piston rod diameters from 5/8" to 1-3/4"
- Maximum pressure rating is 150 psi air
- Standard temperature -10°F to 165°F (-23°C to 74°C)
- All stainless steel construction, except piston (aluminum)
- NPTF ports
- Flexible port and cushion location

**Standard S Series Mounts**

**Centerline Mounts**

X0 Mount  
Basic No Mount

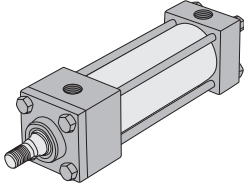

X1 Mount  
Extended Tie Rods – Both Ends

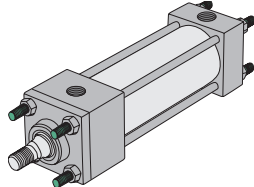

X2 Mount  
Extended Tie Rods – Cap End

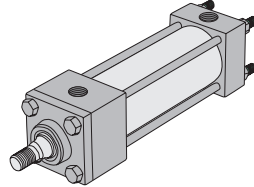

X3 Mount  
Extended Tie Rods – Head End

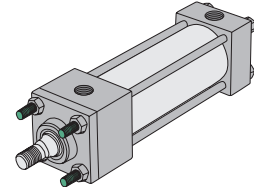

F1 Mount  
Head Rectangular Flange

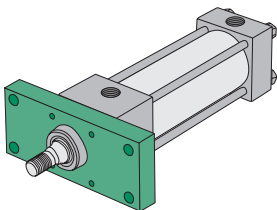

F2 Mount  
Cap Rectangular Flange

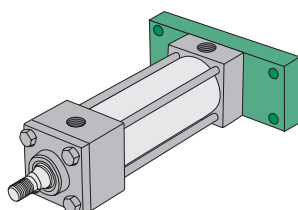

E3 Mount  
Head Square Mount

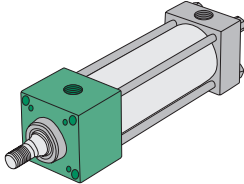

E4 Mount  
Cap Square Mount

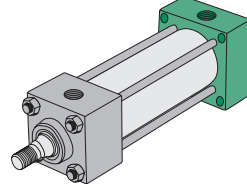

DA Mount  
Double Rod End

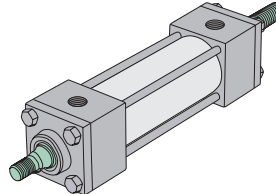

**Pivot Mounts**

P1 Mount  
Fixed Clevis

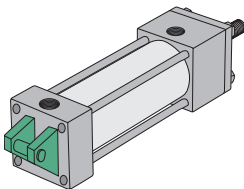

P3 Mount  
Fixed Eye

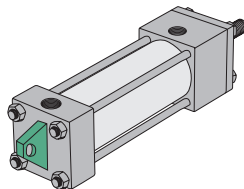

T1 Mount  
Head Trunnion

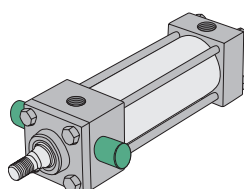

T2 Mount  
Cap Trunnion

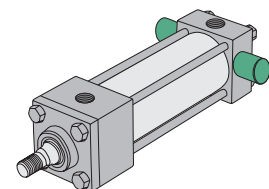

**Foot Mounts**

S1 Mount  
Angle Mount

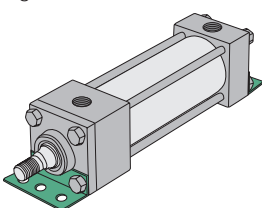

S4 Mount  
Bottom Tapped

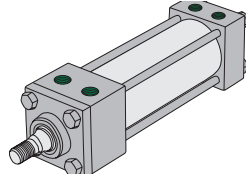

## S Series Cylinder How to Order

**P1 S K - 04 A 1 D - D AA O**

### Mount

- E3\* = Head Square Mount
- E4\* = Cap Square Mount
- F1\*\* = Front Flange
- F2\*\* = Rear Flange
- P1 = Fixed Clevis
- P3 = Fixed Eye
- S1 = Angle Mount
- S4 = Bottom Tapped
- T1 = Head Trunnion
- T2 = Cap Trunnion
- X0 = Basic No Mount
- X1 = Extended Tie Rods (Both Ends)
- X2 = Extended Tie Rod (Cap Only)
- X3 = Extended Tie Rod (Head Only)

\* Only for 8" bore.  
\*\* Only for 1-1/2" - 6" Bores.

### Type

- S = S Series - Stainless Steel  
NFA Interchangeable

### Bore

- K = 1-1/2"
- L = 2"
- M = 2-1/2"
- P = 3-1/4"
- R = 4"
- T = 5"
- U = 6"
- W = 8"

Consult factory for larger bore sizes.

### Full Inches of Stroke

- 00 = 0" Stroke
- 01 = 1" Stroke
- 02 = 2" Stroke
- 03 = 3" Stroke
- 99 = 99" Stroke

### Fractional Inches of Stroke

- A = 0"      I = 1/2"
- B = 1/16"    J = 9/16"
- C = 1/8"      K = 5/8"
- D = 3/16"    L = 11/16"
- E = 1/4"      M = 3/4"
- F = 5/16"    N = 13/16"
- G = 3/8"      O = 7/8"
- H = 7/16"    P = 15/16"

### Magnet

- 0 = No Magnet
- 2 = Reed Magnet

### Options

- AA = No Options
- AP = Anodized Piston
- BA\*\* = Bumpers (Both Ends)
- BC\*\* = Bumper Cap End Only
- BH\*\* = Bumper Head End Only
- DA = Double Rod End
- EB = Silencer Bumpers
- FG = Food Grade Grease
- GA = High Temperature Rod Boot
- KA\* = Stroke Adjuster
- LB = Low Breakaway Seals
- MA = Metallic Rod Scraper
- PA = Polypak Rod Seal
- RB = Rod Boot
- SP = Stainless Steel Piston
- VA = FKM Seals
- 1A\* = Rod Extension
- 2A\* = Thread Extension
- 12\* = Rod and Thread Extension
- 3A = Studded Rod End
- 4A\* = Stop Tube
- 4D\* = Double Piston Stop Tube

\* Specify length.

\*\* Bumpers add .062" to OAL (per bumper).

### Cushions

Position	1	2	3	4	Fixed
No Cushion	A	A	A	A	A
Head and Cap	B	C	D	E	Y
Head Only	F	G	H	J	W
Cap Only	K	L	M	N	V

### Port

Position	1/8"	1/4"	3/8"	1/2"	3/4"
1	B	C	D	E	F
2	H	I	J	K	L
3	N	O	P	Q	R
4	T	U	V	W	X

### Rod Codes

- 1 = Style #1 Standard Rod Diameter
- 2 = Style #2 Standard Rod Diameter
- 3 = Style #3 Standard Rod Diameter
- 4 = Special Standard Rod Diameter  
(must specify threads)
- 5 = Special Oversize Rod Diameter  
(must specify threads)
- 6 = Style #1 Oversize Rod Diameter
- 7 = Style #2 Oversize Rod Diameter
- 8 = Style #3 Oversize Rod Diameter

## Rod Diameter By Bore Size

Bore	Standard Diameter	Oversized Diameter
1-1/2"	0.625	1.000
2"	0.625	1.000
2-1/2"	0.625	1.000
3-1/4"	1.000	1.375
4"	1.000	1.375
5"	1.000	1.375
6"	1.375	1.750
8"	1.375	1.750

## Rod End Styles, Diameters and Threads

Diameter	Style #1 Standard Male	Style #2 Optional Male	Style #3 Optional Female
0.625	7/16-20	1/2-20	7/16-20
1.000	3/4-16	7/8-14	3/4-16
1.375	1-14	1 1/4-12	1-14
1.750	1 1/4-12	1 1/2-12	1 1/4-12

**Loading and Cushioning**

**Load Support System**

Side load and misalignment are major factors that can cause premature failure of the rod bushing and piston, the two load bearing points on a cylinder.

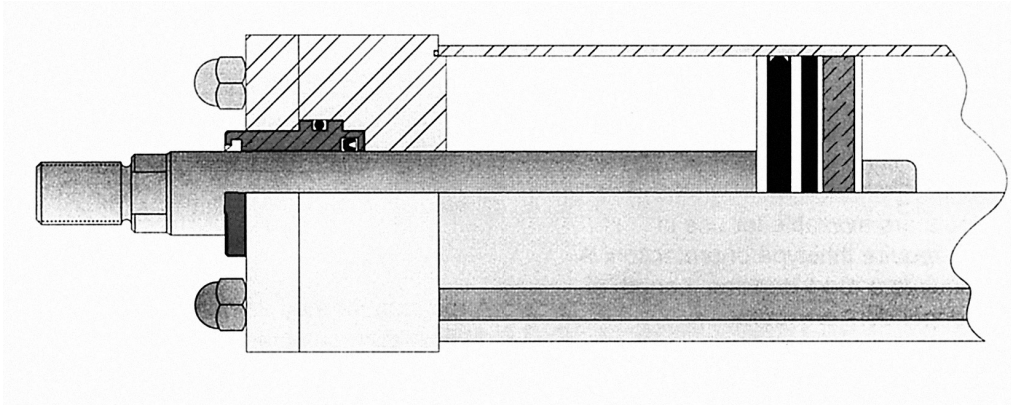

**Rod Bushing**

The S Series includes a cutting edge PolyLube™ composite rod bushing that is extra long in length. The composite rod bushing is specifically designed for applications where corrosion, low friction, and excellent wear characteristics are desired.

**Wear Band**

We separated the load bearing points by locating the wear band at the rear of the piston assembly, to give maximum support even at full extension. The wear band is a stable lubricating strip placed on the rear of the piston. Its width and placement serve to locate piston load at the optimum point. The wear band material has high compression integrity even under heavy loads.

**Cushion Operating Principles**

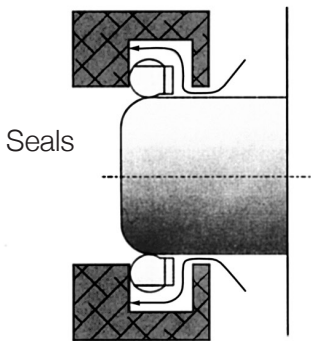

Into Cushion

Our cushion seals have a built-in check function. It seals in one direction and permits full-flow in the opposite direction.

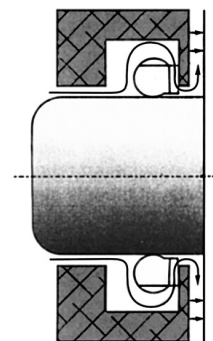

Out of Cushion

PolyLube™ is a registered trademark of Polygon Company. For detailed information regarding the properties of PolyLube™, please call 1-800-918-9261.

## Optional Features

Rod Boots  
RB option-Consult factory  
for additional details

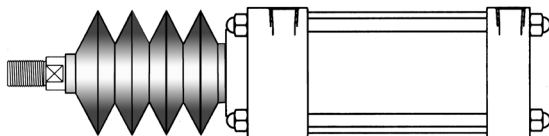

Protective rod boots are available for use in environments that require this type of protection. A Rod Boot also requires a rod extension. Length of rod extension is dependent on stroke. Consult factory for details.

Metallic Rod Scraper  
MA option

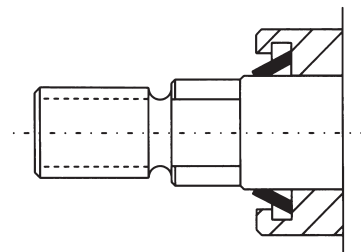

A rod scraper may be necessary when the cylinder must endure paint overspray, weld splatter or fly ash.

Stainless Steel or Anodized Piston  
SP option                      AP option

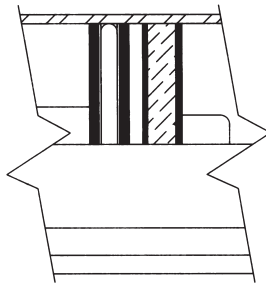

A stainless steel piston is available as well as an anodized piston.

Silencer Bumper Seal  
EB option

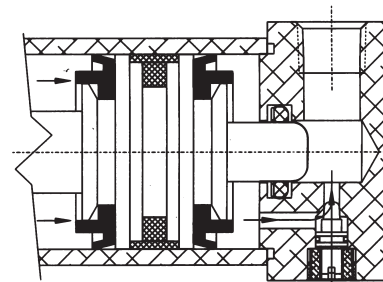

Silencer bumper seal available on cylinders up to 5" bore. Additionally, note that it requires a minimum of 100 psi for the rod to reach the full end of stroke with the EB option.

## Special Cylinders

Special cylinders can be designed upon request. Please consult factory for any of your cylinder needs.

**Dimensions: Inches**

**Basic Cylinder No Mount**

Mount Code X0

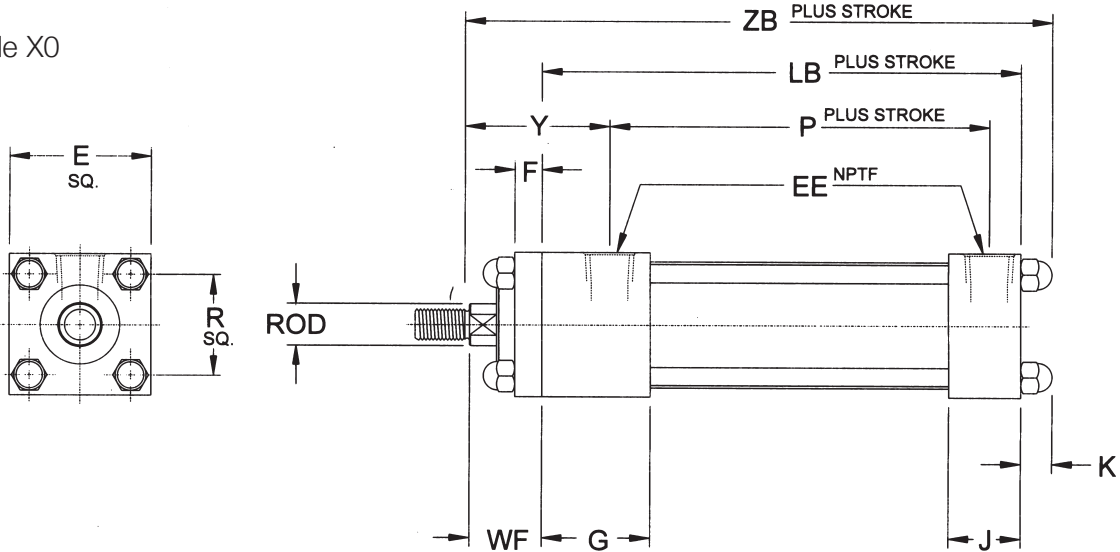

NFPA MX0

Bore	Rod	E	EE	F	G	J	K	LB	P	R	RD	WF	Y
1-1/2"	0.625	2.000	0.375	0.375	1.500	1.000	0.375	3.625	2.313	1.430	1.375	1.000	1.938
	1.000	2.000	0.250	0.375	1.500	1.000	0.375	3.625	2.103	1.430	2.000	1.375	2.460
2"	0.625	2.500	0.375	0.375	1.500	1.000	0.438	3.625	2.250	1.840	1.375	1.000	1.938
	1.000	2.500	0.375	0.375	1.500	1.000	0.438	3.625	2.250	1.840	2.500	1.375	2.313
2-1/2"	.625	3.000	0.375	0.375	1.500	1.000	0.438	3.750	2.375	2.190	1.375	1.000	1.938
	1.000	3.000	0.375	0.375	1.500	1.000	0.438	3.750	2.375	2.190	3.000	1.375	2.313
3-1/4"	1.000	3.750	0.500	0.625	1.750	1.250	0.500	4.250	2.625	2.760	2.706	1.375	2.438
	1.375	3.750	0.500	0.625	1.750	1.250	0.500	4.250	2.625	2.760	3.125	1.625	2.688
4"	1.000	4.500	0.500	0.625	1.750	1.250	0.500	4.250	2.625	3.320	2.706	1.375	2.438
	1.375	4.500	0.500	0.625	1.750	1.250	0.500	4.250	2.625	3.320	3.125	1.625	2.688
5"	1.000	5.500	0.500	0.625	1.750	1.250	0.563	4.500	2.875	4.100	2.706	1.375	2.438
	1.375	5.500	0.500	0.625	1.750	1.250	0.563	4.500	2.875	4.100	3.125	1.625	2.688
6"	1.375	6.500	0.750	0.750	2.000	1.500	0.563	5.000	3.125	4.880	3.125	1.625	2.813
	1.750	6.500	0.750	0.750	2.000	1.500	0.563	5.000	3.125	4.880	3.788	1.875	3.063
8"	1.375	8.500	0.750	0.625	2.000	1.500	1.000	5.125	3.250	6.440	3.125	1.625	2.813
	1.750	8.500	0.750	0.750	2.000	1.500	1.000	5.125	3.250	6.440	3.788	1.875	3.063



## Dimensions: Inches

### Rod Ends

#### Standard and Optional

Style #1 (Standard Male)

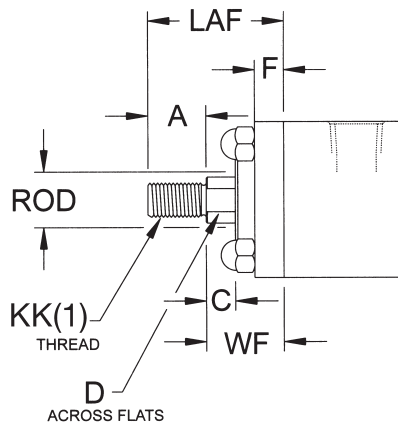

Style #2 (Optional Male)

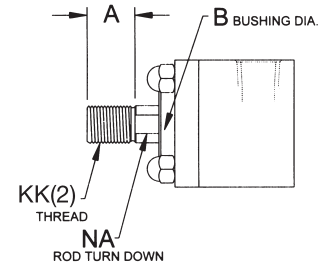

Style #3 (Optional Female)

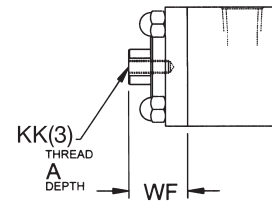

Bore	Rod	KK(1)	KK(2)	KK(3)	A	B	C	D	NA	LAF	WF
1-1/2"	0.625	7/16-20	1/2-20	7/16-20	0.750	1.125	0.375	0.500	0.585	1.750	1.000
	1.000	3/4-16	7/8-14	3/4-16	1.125	1.400	0.500	0.813	0.960	2.500	1.375
2"	0.625	7/16-20	1/2-20	7/16-20	0.750	1.125	0.375	0.500	0.585	1.750	1.000
	1.000	3/4-16	7/8-14	3/4-16	1.125	1.500	0.500	0.813	0.960	2.500	1.375
2-1/2"	0.625	7/16-20	1/2-20	7/16-20	0.750	1.125	0.375	0.500	0.585	1.750	1.000
	1.000	3/4-16	7/8-14	3/4-16	1.125	1.500	0.500	0.813	0.960	2.500	1.375
3-1/4"	1.000	3/4-16	7/8-14	3/4-16	1.125	1.500	0.500	0.813	0.960	2.500	1.375
	1.375	1-14	1 1/4-12	1-14	1.625	2.000	0.625	1.125	1.313	3.230	1.625
4"	1.000	3/4-16	7/8-14	3/4-16	1.125	1.500	0.500	0.813	0.960	2.500	1.375
	1.375	1-14	1 1/4-12	1-14	1.625	2.000	0.625	1.125	1.313	3.250	1.625
5"	1.000	3/4-16	7/8-14	3/4-16	1.125	1.500	0.500	0.813	0.960	2.500	1.375
	1.375	1-14	1 1/4-12	1-14	1.625	2.000	0.625	1.125	1.313	3.250	1.625
6"	1.375	1-14	1 1/4-12	1-14	1.625	2.000	0.625	1.125	1.313	3.250	1.625
	1.750	1 1/4-12	1 1/2-12	1 1/4-12	2.000	2.375	0.750	1.500	1.688	3.875	1.875
8"	1.375	1-14	1 1/4-12	1-14	1.625	2.000	0.625	1.125	1.313	3.250	1.625
	1.750	1 1/4-12	1 1/2-12	1 1/4-12	2.000	2.375	0.750	1.500	1.688	3.875	1.875

**Dimensions: Inches**

**Flange Mounts**

Mount Code F1 - Head Rectangular Flange

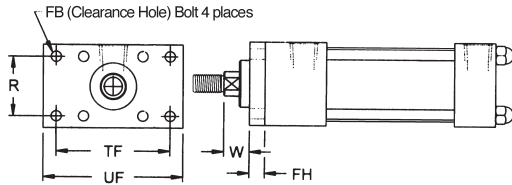

NFPA MF1

Mount Code F2 - Cap Rectangular Flange

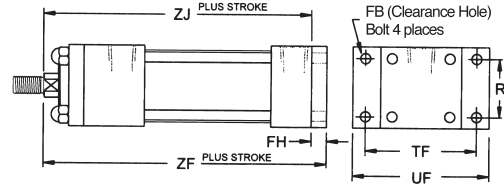

NFPA MF2

Mount Code E3 (8" Bore Only) - Head Square Mount

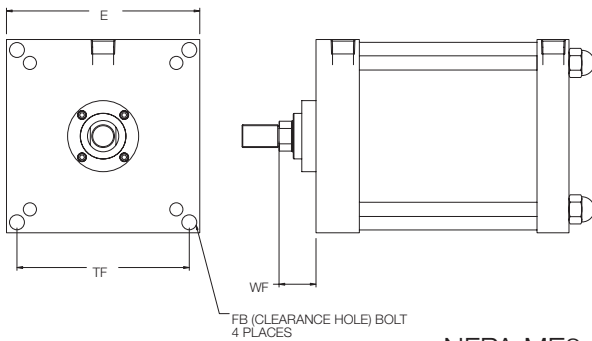

NFPA ME3

Mount Code E4 (8" Bore Only) - Cap Square Mount

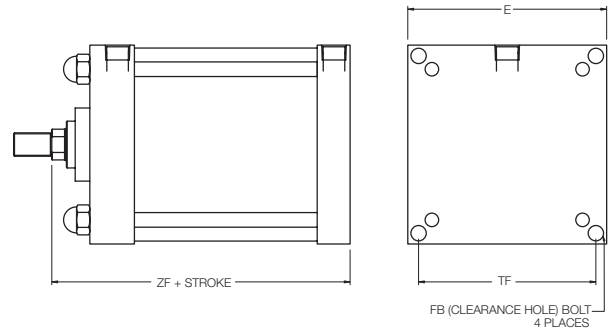

NFPA ME4

Bore	Rod	FB	FH	R	TF	UF	W	ZJ	ZF
1-1/2"	0.625	0.250	0.375	1.430	2.750	3.375	0.625	4.625	5.000
	1.000	0.250	0.375	1.430	2.750	3.375	1.000	5.000	5.375
2"	0.625	0.313	0.375	1.840	3.375	4.125	0.625	4.625	5.000
	1.000	0.313	0.375	1.840	3.375	4.125	1.000	5.000	5.375
2-1/2"	0.625	0.313	0.375	2.190	3.875	4.625	0.625	4.750	5.125
	1.000	0.313	0.375	2.190	3.875	4.625	1.000	5.125	5.500
3-1/4"	1.000	0.375	0.625	2.760	4.688	5.500	0.750	5.625	6.250
	1.375	0.375	0.625	2.760	4.688	5.500	1.000	5.875	6.500
4"	1.000	0.375	0.625	3.320	5.438	6.250	0.750	5.625	6.250
	1.375	0.375	0.625	3.320	5.438	6.250	1.000	5.875	6.500
5"	1.000	0.500	0.625	4.100	6.625	7.625	0.750	5.875	6.500
	1.375	0.500	0.625	4.100	6.625	7.625	1.000	6.125	6.750
6"	1.375	0.500	0.750	4.875	7.625	8.625	0.875	6.625	7.375
	1.750	0.500	0.750	4.875	7.625	8.625	1.125	6.875	7.625
8"	1.375	0.625	N/A	N/A	7.578	N/A	1.625	N/A	6.750
	1.750	0.625	N/A	N/A	7.578	N/A	1.875	N/A	7.000

## Dimensions: Inches

### Bottom Tap and Clevis Mount

Mount Code S4 - Bottom Tapped Mount

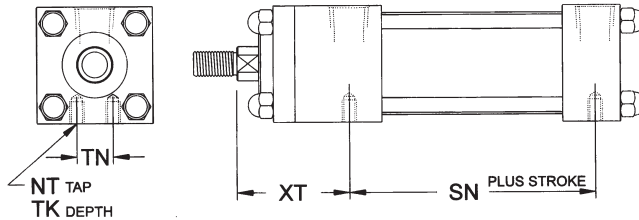

NFPA MS4

Bore	Rod	NT	TK	TN	SN	XT
1-1/2"	0.625	1/4-20	0.375	0.625	2.250	1.938
	1.000	1/4-20	0.313	0.625	2.250	2.313
2"	0.625	5/16-18	0.500	0.875	2.250	1.938
	1.000	5/16-18	0.500	0.875	2.250	2.313
2-1/2"	0.625	3/8-16	0.625	1.250	2.375	1.938
	1.000	3/8-16	0.625	1.250	2.375	2.313
3-1/4"	1.000	1/2-13	0.750	1.500	2.625	2.438
	1.375	1/2-13	0.750	1.500	2.625	2.688
4"	1.000	1/2-13	0.750	2.063	2.625	2.438
	1.375	1/2-13	0.750	2.063	2.625	2.688
5"	1.000	5/8-11	1.000	2.688	2.875	2.438
	1.375	5/8-11	1.000	2.688	2.875	2.688
6"	1.375	3/4-10	1.125	3.250	3.125	2.813
	1.750	3/4-10	1.125	3.250	3.125	3.063
8"	1.375	3/4-10	1.125	4.500	3.250	2.813
	1.750	3/4-10	1.125	4.500	3.250	3.063

Mount Code P1 - Fixed Clevis Mount

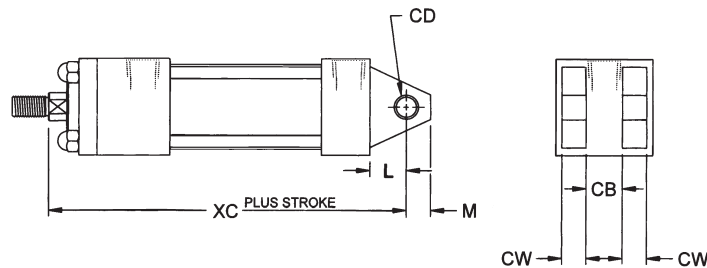

NFPA MP1

Bore	Rod	CB	CD	CW	L	M	XC
1-1/2"	0.625	0.750	0.500	0.500	0.750	0.500	5.375
	1.000	0.750	0.500	0.500	0.750	0.500	5.750
2"	0.625	0.750	0.500	0.500	0.750	0.500	5.375
	1.000	0.750	0.500	0.500	0.750	0.500	5.750
2-1/2"	0.625	0.750	0.500	0.500	0.750	0.500	5.500
	1.000	0.750	0.500	0.500	0.750	0.500	5.875
3-1/4"	1.000	1.250	0.750	0.625	1.250	0.750	6.875
	1.375	1.250	0.750	0.625	1.250	0.750	7.125
4"	1.000	1.250	0.750	0.625	1.250	0.750	6.875
	1.375	1.250	0.750	0.625	1.250	0.750	7.125
5"	1.000	1.250	0.750	0.625	1.250	0.750	7.125
	1.375	1.250	0.750	0.625	1.250	0.750	7.375
6"	1.375	1.500	1.000	0.750	1.500	1.000	8.125
	1.750	1.500	1.000	0.750	1.500	1.000	8.375
8"	1.375	1.500	1.000	0.750	1.500	1.000	8.250
	1.750	1.500	1.000	0.750	1.500	1.000	8.500

**Dimensions: Inches**

**Extended Tie Rod Mounts**

Mount Code X3 - Extended Tie Rods - Head End

NFPA MX3

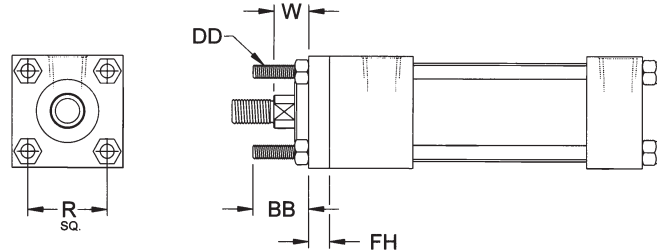

Mount Code X2 - Extended Tie Rods - Cap End

NFPA MX2

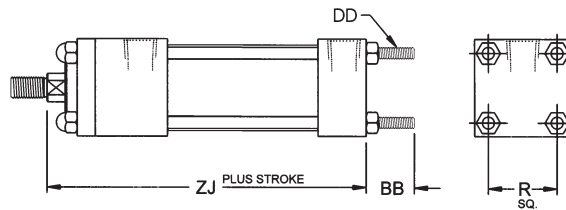

Mount Code X1 - Extended Tie Rods - Both Ends

NFPA MX1

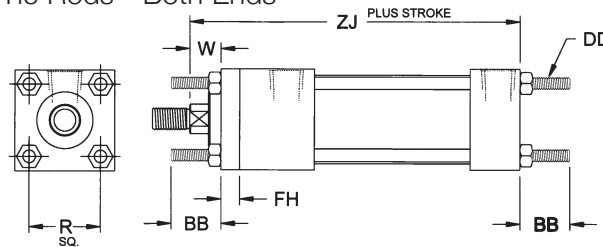

Bore	Rod	BB	DD	FH	R	W	ZJ
1-1/2"	0.625	1.000	1/4-28	0.375	1.430	0.625	4.625
	1.000	1.000	1/4-28	0.375	1.430	1.000	5.000
2"	0.625	1.125	5/16-24	0.375	1.840	0.625	4.625
	1.000	1.125	5/16-24	0.375	1.840	1.000	5.000
2-1/2"	0.625	1.125	5/16-24	0.375	2.190	0.625	4.750
	1.000	1.125	5/16-24	0.375	2.190	1.000	5.125
3-1/4"	1.000	1.375	3/8-24	0.625	2.760	0.750	5.625
	1.375	1.375	3/8-24	0.625	2.760	1.000	5.875
4"	1.000	1.375	3/8-24	0.625	3.320	0.750	5.625
	1.375	1.375	3/8-24	0.625	3.320	1.000	5.875
5"	1.000	1.813	1/2-20	0.625	4.100	0.750	5.875
	1.375	1.813	1/2-20	0.625	4.100	1.000	6.125
6"	1.375	1.813	1/2-20	0.750	4.880	0.875	6.625
	1.750	1.813	1/2-20	0.750	4.880	1.125	6.875
8"	1.375	2.313	5/8-18	N/A	6.440	1.625	6.750
	1.750	2.313	5/8-18	N/A	6.440	1.875	7.000

**Dimensions: Inches**

## Trunnion Mounts

Mount Code T1 - Head Trunnion Mount

NFPA MT1

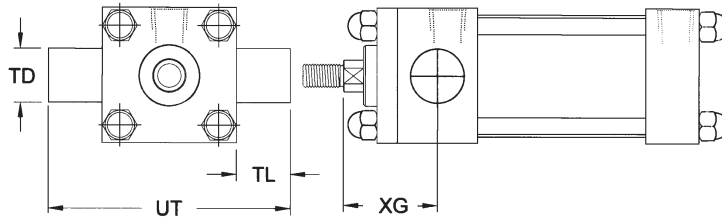

Mount Code T2 - Cap Trunnion Mount

NFPA MT2

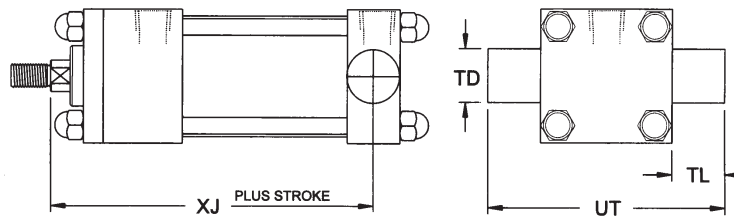

Bore	Rod	TD	TL	UT	XG	XJ
1-1/2"	0.625	1.000	1.000	4.000	1.750	4.125
	1.000	1.000	1.000	4.000	2.125	4.500
2"	0.625	1.000	1.000	4.500	1.750	4.125
	1.000	1.000	1.000	4.500	2.125	4.500
2-1/2"	0.625	1.000	1.000	5.000	1.750	4.250
	1.000	1.000	1.000	5.000	2.125	4.625
3-1/4"	1.000	1.000	1.000	5.750	2.250	5.000
	1.375	1.000	1.000	5.750	2.500	5.250
4"	1.000	1.000	1.000	6.500	2.250	5.000
	1.375	1.000	1.000	6.500	2.500	5.250
5"	1.000	1.000	1.000	7.500	2.250	5.250
	1.375	1.000	1.000	7.500	2.500	5.500
6"	1.375	1.375	1.375	9.250	2.625	5.875
	1.750	1.375	1.375	9.250	2.875	6.125
8"	1.375	1.375	1.375	11.250	2.625	6.000
	1.750	1.375	1.375	11.250	2.875	6.250

**Dimensions: Inches**

**Double Rod End Cylinders**

This configuration has a piston rod which extends out both ends of the cylinder. It is also called a through rod cylinder.

DA Option

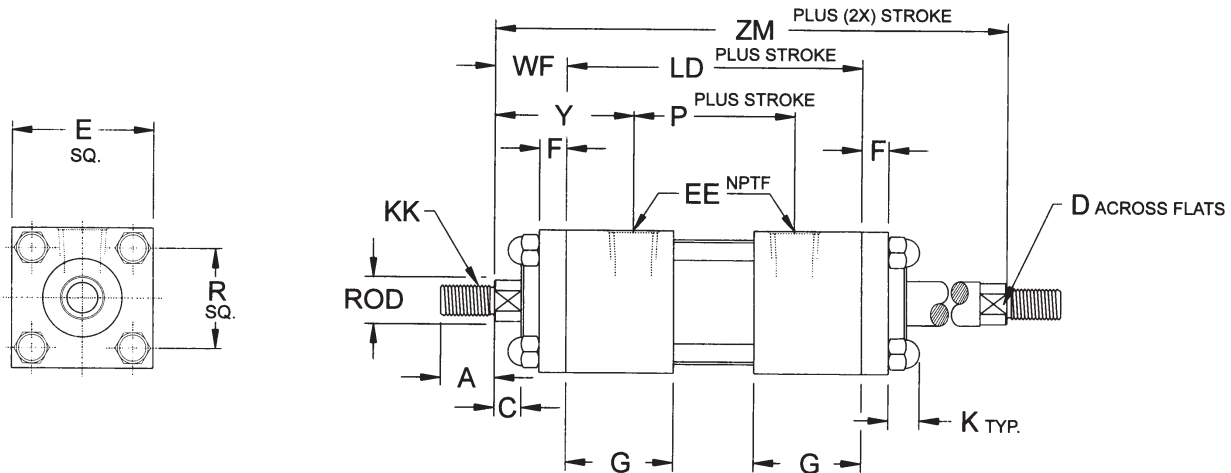

Bore	Rod	A	C	D	E	EE	F	G	K	KK	LD	P	R	SN	SS	RD	WF	Y	ZM
1-1/2"	0.625	0.750	0.375	0.500	2.000	0.375	0.375	1.500	0.375	7/16-20	4.125	2.250	1.430	2.250	3.375	1.375	1.000	1.938	6.125
	1.000	1.125	0.500	0.813	2.000	0.250	0.375	1.500	0.375	3/4-16	4.125	1.955	1.430	2.250	3.375	2.000	1.375	2.460	6.875
2"	0.625	0.750	0.375	0.500	2.500	0.375	0.375	1.500	0.438	7/16-20	4.125	2.250	1.840	2.250	3.375	1.375	1.000	1.938	6.125
	1.000	1.125	0.500	0.813	2.500	0.375	0.375	1.500	0.438	3/4-16	4.125	2.250	1.840	2.250	3.375	2.500	1.375	2.313	6.875
2-1/2"	0.625	0.750	0.375	0.500	3.000	0.375	0.375	1.500	0.438	7/16-20	4.250	2.375	2.190	2.375	3.500	1.375	1.000	1.938	6.250
	1.000	1.125	0.500	0.813	3.000	0.375	0.375	1.500	0.438	3/4-16	4.250	2.375	2.190	2.375	3.500	3.000	1.375	2.313	7.000
3-1/4"	1.000	1.125	0.500	0.813	3.750	0.500	0.625	1.750	0.500	3/4-16	4.750	2.625	2.760	2.625	3.750	2.706	1.375	2.438	7.500
	1.375	1.625	0.625	1.125	3.750	0.500	0.625	1.750	0.500	1-14	4.750	2.625	2.760	2.625	3.750	3.125	1.625	2.688	8.000
4"	1.000	1.125	0.500	0.813	4.500	0.500	0.625	1.750	0.500	3/4-16	4.750	2.625	3.320	2.625	3.750	2.706	1.375	2.438	7.500
	1.375	1.625	0.625	1.125	4.500	0.500	0.625	1.750	0.500	1-14	4.750	2.625	3.320	2.625	3.750	3.125	1.625	2.688	8.000
5"	1.000	1.125	0.500	0.813	5.500	0.500	0.625	1.750	0.563	3/4-16	5.000	2.875	4.100	2.875	3.625	2.706	1.375	2.438	7.500
	1.375	1.625	0.625	1.125	5.500	0.500	0.625	1.750	0.563	1-14	5.000	2.875	4.100	2.875	3.625	3.125	1.625	2.688	8.250
6"	1.375	1.625	0.625	1.125	6.500	0.750	0.625	2.000	0.563	1-14	5.500	3.125	4.880	3.125	4.125	3.125	1.625	2.813	8.750
	1.750	2.000	0.750	1.500	6.500	0.750	0.750	2.000	0.563	1 1/4-12	5.500	3.125	4.880	3.125	4.125	3.788	1.875	3.063	9.250
8"	1.375	1.625	0.625	1.125	8.500	0.750	0.625	2.000	1.000	1-14	5.625	3.250	6.440	3.250	4.250	3.125	1.625	2.813	8.875
	1.750	2.000	0.750	1.500	8.500	0.750	0.750	2.000	1.000	1 1/4-12	5.625	3.250	6.440	3.250	4.250	3.788	1.875	3.063	9.375

## Dimensions: Inches

### Accessories - Stainless Steel

#### Eye Bracket

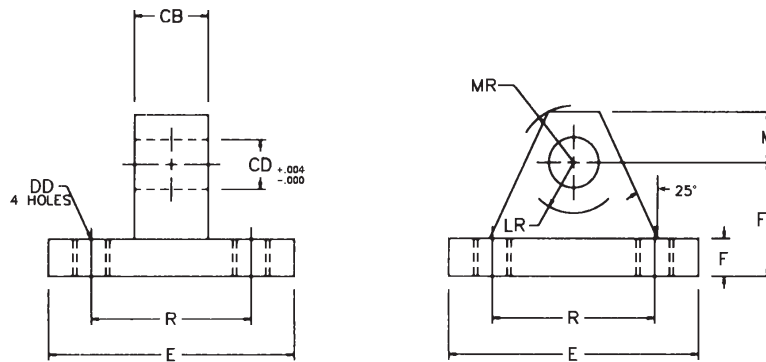

#### Rod Clevis

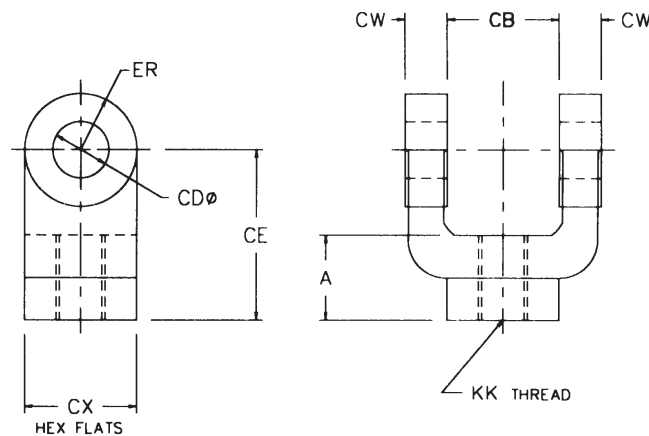

Part No.	A	CA	CB	CD	CE	CW	CX	DD	E	ER	F	FL	KK	LR	M	MR	R
<b>Eye Bracket</b>																	
S500-101	-	-	0.750	0.500	-	-	-	0.406	2.500	-	0.375	1.125	-	0.750	0.500	0.563	1.630
S500-102	-	-	1.250	0.750	-	-	-	0.531	3.500	-	0.625	1.875	-	1.250	0.750	0.875	2.560
S500-103	-	-	1.500	1.000	-	-	-	0.656	4.500	-	0.750	2.250	-	1.500	1.000	1.250	3.250
S500-104	-	-	2.000	1.375	-	-	-	0.656	5.000	-	0.875	3.000	-	2.125	1.375	1.625	3.810
S500-105	-	-	2.500	1.750	-	-	-	0.906	6.500	-	0.875	3.125	-	2.250	1.750	2.125	4.950
<b>Rod Clevis</b>																	
S500-301	0.750	-	0.750	0.500	1.500	0.500	1.000	-	-	0.500	-	-	7/16-20	-	-	-	-
S500-302	0.750	-	0.750	0.500	1.500	0.500	1.000	-	-	0.500	-	-	1/2-20	-	-	-	-
S500-303	1.125	-	1.250	0.750	2.375	0.625	1.250	-	-	0.750	-	-	3/4-16	-	-	-	-
S500-304	1.625	-	1.500	1.000	3.125	0.750	1.500	-	-	1.000	-	-	7/8-14	-	-	-	-
S500-305	1.625	-	1.500	1.000	3.125	0.750	1.500	-	-	1.000	-	-	1-14	-	-	-	-
S500-306	2.000	-	2.000	1.375	4.125	1.000	2.000	-	-	1.375	-	-	1 1/4-12	-	-	-	-
S500-307	2.250	-	2.500	1.750	4.500	1.250	2.375	-	-	1.750	-	-	1 1/4-12	-	-	-	-

**Dimensions: Inches**

**Rod Couplers**

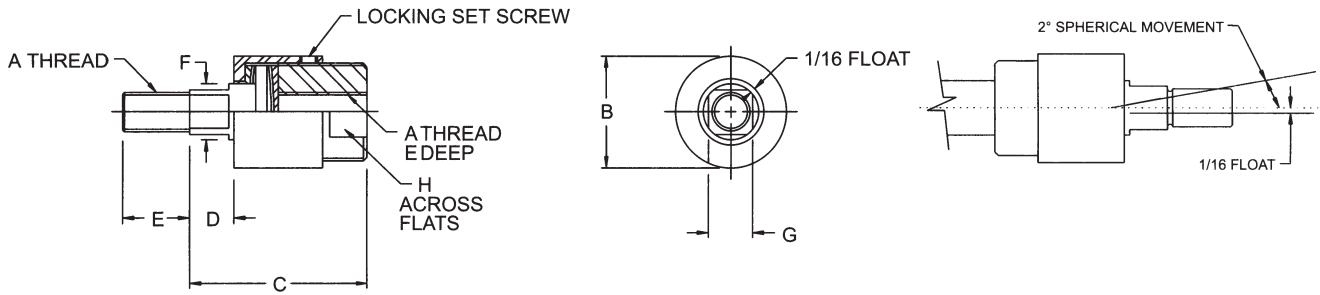

**Standard Couplers**

Part No.		A	B	C	D	E	F	G	H	Maximum Pull Load
Standard	Nickel									
A500-603	B500-603	7/16-20	1 1/4	2	1/2	3/4	5/8	1/2	1	2,535
A500-604	B500-604	1/2-20	1 1/4	2	1/2	3/4	5/8	1/2	1	3,500
A500-605	B500-605	5/8-18	1 1/4	2	1/2	3/4	5/8	1/2	1	4,750
A500-606	B500-606	3/4-16	1 3/4	2 5/16	1/2	1 1/8	31/32	13/16	1 1/2	8,750
A500-607	B500-607	7/8-14	1 3/4	2 5/16	1/2	1 1/8	31/32	13/16	1 1/2	9,750
A500-608	B500-608	1-14	2 1/2	2 15/16	1/2	1 5/8	1 3/8	1 5/32	2 1/4	16,125
A500-609	B500-609	1 1/4-12	2 1/2	2 15/16	1/2	1 5/8	1 3/8	1 5/32	2 1/4	19,600
A500-610	N35-1004	1 1/2-12	3 1/4	4 3/8	13/16	2 1/4	1 3/4	1 1/2	3	34,000



## S Series Switch Information

### S Series World Switch Application Detail

#### Round Tube and Tie Rod Detail

1. World Switch
2. Tie Rod Bracket
3. Adjustment Screw
4. Cylinder Tie Rod

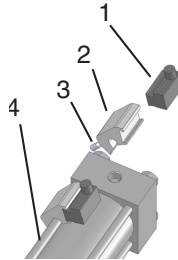

#### S Series World Switch Bracket

Cylinders	Bore	Part Number
S series Tie Rod	1 1/2"	SB6-K01
S series Tie Rod	2"-2 1/2"	SB6-L01
S series Tie Rod	3 1/4"-4"	SB6-P01
S series Tie Rod	5"-6"	SB6-T01
S series Tie Rod	8"	SB6-W01

#### S Series World Switch Hall Effect Part Numbers

P/N	Switch Style	Electrical Design	Output	Operating Voltage	Current Rating	Switching Power	Voltage Drop	NEMA IP Rating	Temperature Rating
SH6-031	Flying Lead	PNP	Normally Open	6-24 VDC	0.3 Amps Max.	7.2 Watts Max.	.5 Volts	NEMA 6	-25° to +75° C
SH6-032	Flying Lead	NPN	Normally Open	6-24 VDC	0.3 Amps Max.	7.2 Watts Max.	.5 Volts	NEMA 6	-25° to +75° C
SH6-021	M8 Connector	PNP	Normally Open	6-24 VDC	0.3 Amps Max.	7.2 Watts Max.	.5 Volts	NEMA 6	-25° to +75° C
SH6-022	M8 Connector	NPN	Normally Open	6-24 VDC	0.3 Amps Max.	7.2 Watts Max.	.5 Volts	NEMA 6	-25° to +75° C

### Hall Effect Switch

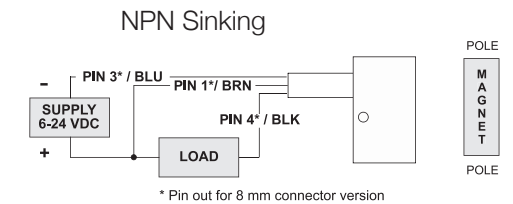
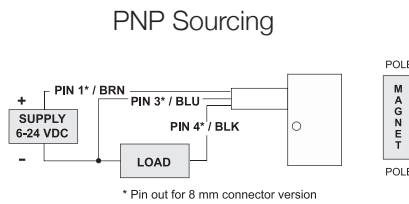
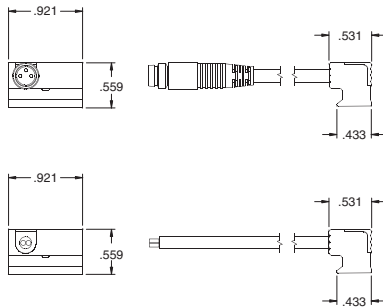

## S Series World Switch Reed Switch Part Numbers

P/N	Switch Style	Electrical Design	Output	Operating Voltage	Current Rating	Switching Power	Voltage Drop	NEMA IP Rating	Temperature Rating
SR6-002	Flying Lead	AC/DC REED	Normally Open	5-120 VAC/ DC	0.025 Amps Max. 0.001 Amps Min.	3 Watts Max.	3.5 Volts	NEMA 6	-25° to +75° C
SR6-004	Flying Lead	AC/DC REED	Normally Open	5-120 VAC/ DC	0.5 Amps Max. 0.005 Amps Min.	10 Watts Max.	3.0 Volts	NEMA 6	-25° to +75° C
SR6-022	M8 Connector	AC/DC REED	Normally Open	5-50 VAC 5-60 VDC	0.025 Amps Max. 0.001 Amps Min.	3 Watts Max.	.5 Volts	NEMA 6	-25° to +75° C
SR6-024	M8 Connector	AC/DC REED	Normally Open	5-50 VAC 5-60 VDC	0.5 Amps Max. 0.005 Amps Min.	10 Watts Max.	3.0 Volts	NEMA 6	-25° to +75° C

## Reed Switch - Normally Open Type SR6

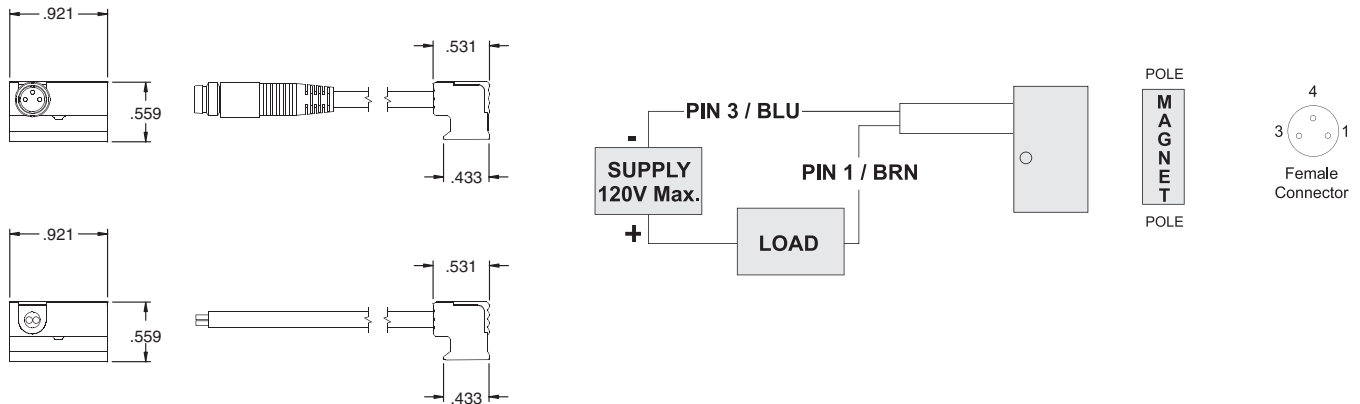

## NFPA Interchangeable Cylinders

### S Series (Tie Rod)

Bore	Bracket P/N
1 1/2"	N99-1181
2"	N99-1182
2 1/2"	N99-1182
3 1/4"	N99-1183
4"	N99-1183
5"	N99-1184
6"	N99-1184
8"	N99-1184
10"	N99-1191
12"	N99-1191
14"	N99-1200

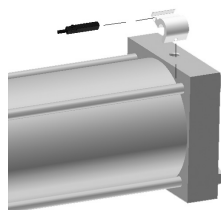

Sensor Description	Standard Cord Set	Quick Disconnect
Reed Switch	REED-FL2-00	REED-QDS-M8U
Hall PNP	PNP-FL2-00-U	PNP-QDS-M8-U
Hall NPN	NPN-FL2-00-U	NPN-QDS-M8-U

See page 19, 20, & 21 for sensor specifications

## Sensing Part Numbers

### PNP-FL2-00-U

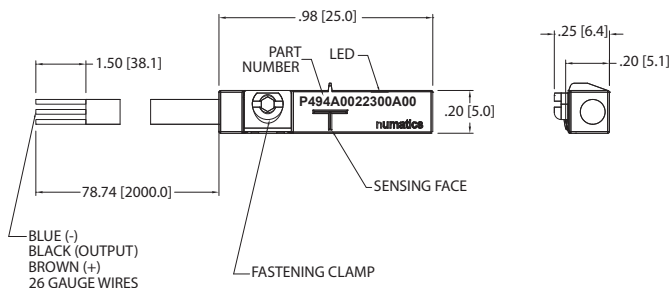

### PNP-QDS-M8-U

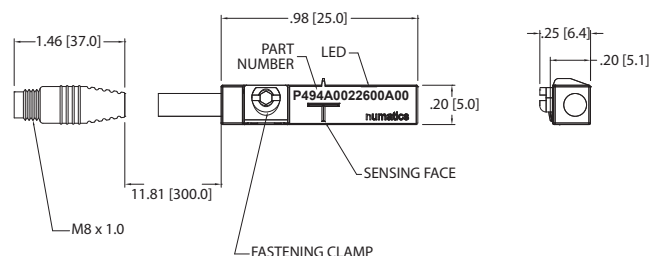

ELECTRICAL DESIGN	DC PNP
OUTPUT	Normally Open
OPERATING VOLTAGE	10-30 VDC
CURRENT RATING	100 mA
SHORT-CIRCUIT PROTECTION	Yes
OVERLOAD PROTECTION	Yes
REVERSE POLARITY PROTECTION	Yes
VOLTAGE DROP	< 2.5 V
CURRENT CONSUMPTION	< 12 mA
REPEATABILITY	< .2mm
POWER-ON DELAY TIME	< 30 ms
SWITCH FREQUENCY	> 3000 Hz
AMBIENT TEMPERATURE	-25°C to 85°C
PROTECTION	IP 67, III
HYSTERESIS	1.0mm
MAGNETIC SENSITIVITY	2.0 mT
TRAVEL SPEED	> 10 m/s
HOUSING MATERIAL	PA (Polyamide) Black; Fastening Clamp: Stainless Steel
FUNCTION DISPLAY SWITCHING STATUS	Yellow LED
CONNECTION	Flying Leads, Pur Cable (2m Long, 3 x26 Gauge Wire)
REMARKS	Clamping Screw with Combined Slot/Hexagon Socket Head AF 1.5 cULus - Class 2 Source Required
ACCESSORIES	Rubber Placeholder, Cable Clip, and Cut Sheet To Be Provided with Every Switch
AGENCY APPROVALS	<b>CE</b> <b>cUL</b> <b>US</b> <b>RoHS</b>

ELECTRICAL DESIGN	DC PNP
OUTPUT	Normally Open
OPERATING VOLTAGE	10-30 VDC
CURRENT RATING	100 mA
SHORT-CIRCUIT PROTECTION	Yes
OVERLOAD PROTECTION	Yes
REVERSE POLARITY PROTECTION	Yes
VOLTAGE DROP	< 2.5 V
CURRENT CONSUMPTION	< 12 mA
REPEATABILITY	< .2mm
POWER-ON DELAY TIME	< 30 ms
SWITCH FREQUENCY	> 3000 Hz
AMBIENT TEMPERATURE	-25°C to 85°C
PROTECTION	IP 67, III
HYSTERESIS	1.0mm
MAGNETIC SENSITIVITY	2.0 mT
TRAVEL SPEED	> 10 m/s
HOUSING MATERIAL	PA (Polyamide) Black; Fastening Clamp: Stainless Steel
FUNCTION DISPLAY SWITCHING STATUS	Yellow LED
CONNECTION	M8 Connector (Snap Fit) , Pur Cable (.3 m)
REMARKS	Clamping Screw with Combined Slot/Hexagon Socket Head AF 1.5 cULus - Class 2 Source Required
ACCESSORIES	Rubber Placeholder, Cable Clip, and Cut Sheet To Be Provided with Every Switch
AGENCY APPROVALS	<b>CE</b> <b>cUL</b> <b>US</b> <b>RoHS</b>

\*Switches are not designed for wet environments. Please see your distributor for additional information.

Information subject to change without notice. For ordering information or regarding your local sales office visit [www.numatics.com](http://www.numatics.com).

**Sensing Part Numbers**

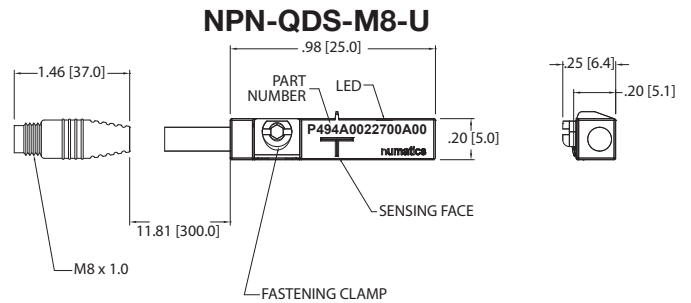
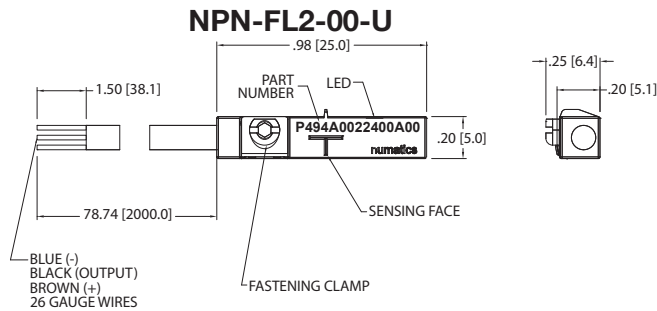



ELECTRICAL DESIGN	DC NPN
OUTPUT	Normally Open
OPERATING VOLTAGE	10-30 VDC
CURRENT RATING	100 mA
SHORT-CIRCUIT PROTECTION	Yes
OVERLOAD PROTECTION	Yes
REVERSE POLARITY PROTECTION	Yes
VOLTAGE DROP	< 2.5 V
CURRENT CONSUMPTION	< 12 mA
REPEATABILITY	< .2mm
POWER-ON DELAY TIME	< 30 ms
SWITCH FREQUENCY	> 3000 Hz
AMBIENT TEMPERATURE	-25°C to 85°C
PROTECTION	IP 67, III
HYSTERESIS	1.0mm
MAGNETIC SENSITIVITY	2.0 mT
TRAVEL SPEED	> 10 m/s
HOUSING MATERIAL	PA (Polyamide) Black; Fastening Clamp: Stainless Steel
FUNCTION DISPLAY SWITCHING STATUS	Yellow LED
CONNECTION	Flying Leads, Pur Cable (2m Long, 3 x26 Gauge Wire)
REMARKS	Clamping Screw with Combined Slot/Hexagon Socket Head AF 1.5 cULus - Class 2 Source Required
ACCESSORIES	Rubber Placeholder, Cable Clip, and Cut Sheet To Be Provided with Every Switch
AGENCY APPROVALS	<b>CE</b> <b>cUL</b> <b>US</b> <b>RoHS</b>

ELECTRICAL DESIGN	DC NPN
OUTPUT	Normally Open
OPERATING VOLTAGE	10-30 VDC
CURRENT RATING	100 mA
SHORT-CIRCUIT PROTECTION	Yes
OVERLOAD PROTECTION	Yes
REVERSE POLARITY PROTECTION	Yes
VOLTAGE DROP	< 2.5 V
CURRENT CONSUMPTION	< 12 mA
REPEATABILITY	< .2mm
POWER-ON DELAY TIME	< 30 ms
SWITCH FREQUENCY	> 3000 Hz
AMBIENT TEMPERATURE	-25°C to 85°C
PROTECTION	IP 67, III
HYSTERESIS	1.0mm
MAGNETIC SENSITIVITY	2.0 mT
TRAVEL SPEED	> 10 m/s
HOUSING MATERIAL	PA (Polyamide) Black; Fastening Clamp: Stainless Steel
FUNCTION DISPLAY SWITCHING STATUS	Yellow LED
CONNECTION	M8 Connector (Snap Fit) , Pur Cable (.3 m)
REMARKS	Clamping Screw with Combined Slot/Hexagon Socket Head AF 1.5 cULus - Class 2 Source Required
ACCESSORIES	Rubber Placeholder, Cable Clip, and Cut Sheet To Be Provided with Every Switch
AGENCY APPROVALS	<b>CE</b> <b>cUL</b> <b>US</b> <b>RoHS</b>

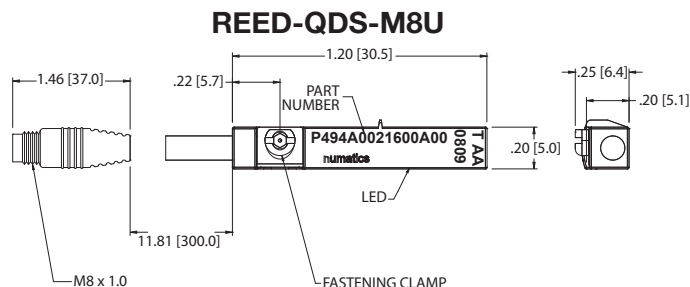
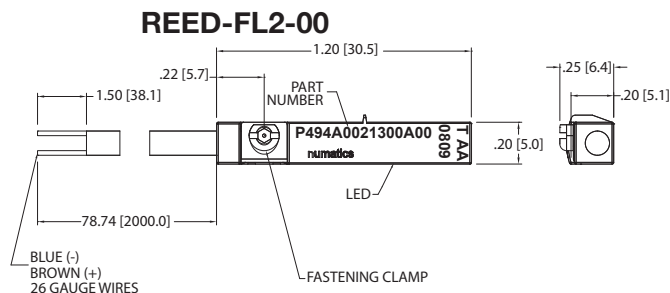
## Sensing Part Numbers



ELECTRICAL DESIGN	AC/DC REED
OUTPUT	Normally Open
OPERATING VOLTAGE	5-120 VAC/DC
CURRENT RATING	100 mA*
SHORT-CIRCUIT PROTECTION	No
OVERLOAD PROTECTION	No
REVERSE POLARITY PROTECTION	Yes
VOLTAGE DROP	< 5 V
REPEATABILITY	± .2mm
MAKETIME INCLUDING BOUNCE	< .6 ms
BREAKTIME	< .1 ms
SWITCHING POWER (MAX)	5 W
SWITCH FREQUENCY	1000 Hz
AMBIENT TEMPERATURE	-25°C to 70°C
PROTECTION	IP 67, II
HYSTERESIS	.9mm
HOUSING MATERIAL	PA (Polyamide) Black; Fastening Clamp: Stainless Steel
FUNCTION DISPLAY SWITCHING STATUS	Yellow LED
CONNECTION	Flying Leads, Pur Cable (2m Long, 2 x26 Gauge Wire)
REMARKS	*External Protective Circuit for Inductive Load (Valve, Contactor, Etc.) Necessary. Conforms to 2008 NEC Section 725 III, Class 2 Circuits Clamping Screw with Combined Slot/Hexagon Socket Head AF 1.5. No LED Function in case of Polarity in DC Operation
ACCESSORIES	Rubber Placeholder, Cable Clip, and Cut Sheet To Be Provided with Every Switch
AGENCY APPROVALS	 <b>RoHS</b>

ELECTRICAL DESIGN	AC/DC REED
OUTPUT	Normally Open
OPERATING VOLTAGE	*5-60 VDC / 5-50 VAC
CURRENT RATING	100 mA
SHORT-CIRCUIT PROTECTION	No
OVERLOAD PROTECTION	No
REVERSE POLARITY PROTECTION	Yes
VOLTAGE DROP	< 5 V
REPEATABILITY	± .2mm
MAKETIME INCLUDING BOUNCE	< .6 ms
BREAKTIME	< .1 ms
SWITCHING POWER (MAX)	5 W
SWITCH FREQUENCY	1000 Hz
AMBIENT TEMPERATURE	-25°C to 70°C
PROTECTION	IP 67, II
HYSTERESIS	.9mm
HOUSING MATERIAL	PA (Polyamide) Black; Fastening Clamp: Stainless Steel
FUNCTION DISPLAY SWITCHING STATUS	Yellow LED
CONNECTION	M8 Connector (Snap Fit), Pur Cable (.3m)
REMARKS	*External Protective Circuit for Inductive Load (Valve, Contactor, Etc.) Necessary. Conforms to 2008 NEC Section 725 III, Class 2 Circuits M8 Connector voltage limited to 5-60 vdc / 5-50 vac to conform with 2008 IEC 61076-2-104 Clamping Screw with Combined Slot/Hexagon Socket Head AF 1.5. No LED Function in case of Polarity in DC Operation
ACCESSORIES	Rubber Placeholder, Cable Clip, and Cut Sheet To Be Provided with Every Switch
AGENCY APPROVALS	 <b>RoHS</b>

\*Switches are not designed for wet environments. Please see your distributor for additional information.

Information subject to change without notice. For ordering information or regarding your local sales office visit [www.numatics.com](http://www.numatics.com).

**Quick Disconnect Cables**

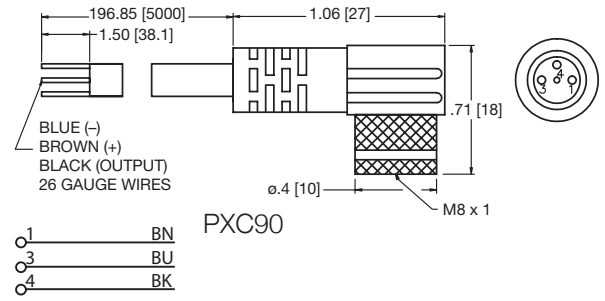
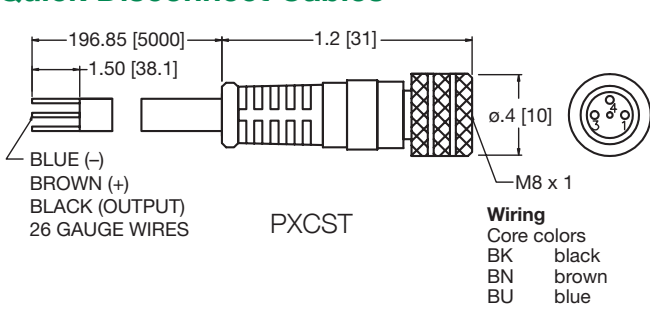

Order Code	Type	Operating Voltage	Current Rating	Cable Material	Protection	Connector
PXCST	Straight 5 m Cable (3 x 26 Gauge wire)	60 AC/75 DC	3 A	PUR	IP 68, III	M8
PXC90	90° 5 m Cable (3 x 26 Gauge wire)	60 AC/75 DC	3 A	PUR	IP 68, III	M8

## How to Order - S Series Piston Rod Assembly

**S92 - K 1 N 0 - 01 A - AA**

**Type**  
S92 = S Series Piston Rod Assembly

**Bore**  
K = 1-1/2"    R = 4"  
L = 2"        T = 5"  
M = 2-1/2"   U = 6"  
P = 3-1/4"   W = 8"

**Rod Code**  
1 = Style # 1 Standard Rod Diameter  
2 = Style # 2 Standard Rod Diameter  
3 = Style # 3 Standard Rod Diameter  
4 = Special Standard Rod Diameter  
    (must specify threads)  
5 = Special Rod End Oversize Rod Diameter  
    (must specify threads)  
6 = Style #1 Oversize Rod Diameter  
7 = Style #2 Oversize Rod Diameter  
8 = Style #3 Oversize Rod Diameter

**Cushion**  
N = No Cushion  
B = Both Ends Cushioned  
H = Head End Cushioned  
C = Cap End Cushioned

**Magnet**  
0 = No Magnet  
2 = Reed Magnet  
3 = Hall Magnet

**Option**  
AA = No Option  
AP = Anodized Piston  
BC = Bumpered Cap End  
BH = Bumpered Head End  
DA = Double Rod  
EB = Silencer Bumpers  
FA = No Wrench Flats, No Turn Down  
FB = Four Wrench Flats  
GA = High Temperature Rod Boot  
KA = Stroke Adjust  
LB = Low Breakaway  
RB = Rod Boot  
RA = Save Air Stroke Adjuster  
SP = Stainless Piston  
VA = FKM Seals  
1A\* = Rod Extension  
1B\* = Rear Rod Extension  
2A\* = Thread Extension  
2B\* = Rear Thread Extension  
3A = Rod Stud  
3B = Rear Rod Stud  
4A\* = Stop Tube  
4D\* = Double Piston Stop Tube

\* = must specify length

**Fractional Inches of Stroke**  
A = 0"    E = 1/4"    I = 1/2"    M = 3/4"  
B = 1/16"    F = 5/16"    J = 9/16"    N = 13/16"  
C = 1/8"    G = 3/8"    K = 5/8"    O = 7/8"  
D = 3/16"    H = 7/16"    L = 11/16"    P = 15/16"

**Full Inches of Stroke**  
00 = 0" Stroke  
01 = 1" Stroke  
02 = 2" Stroke  
03 = 3" Stroke  
99 = 99" Stroke

Note: Options listed are ones that apply to a piston rod assembly only.  
Model number is set up to use option code supplied with original cylinder or with any above.

### Rod End Styles, Diameters and Threads

Diameter	Style #1 Standard Male	Style #2 Optional Male	Style #3 Optional Female
0.625	7/16-20	1/2-20	7/16-20
1.000	3/4-16	7/8-14	3/4-16
1.375	1-14	1 1/4-12	1-14
1.750	1 1/4-12	1 1/2-12	1 1/4-12

### Rod Diameter by Bore Size

Bore	Standard Diameter	Oversized Diameter
1-1/2"	0.625	1.000
2"	0.625	1.000
2-1/2"	0.625	1.000
3-1/4"	1.000	1.375
4"	1.000	1.375
5"	1.000	1.375
6"	1.375	1.750
8"	1.375	1.750

## How to Order - S Series Repair Kit

**S98 - K 1 N - AA**

### Type

S98 = S Series Repair Kit

### Bore

K = 1-1/2"    R = 4"  
 L = 2"        T = 5"  
 M = 2-1/2"    U = 6"  
 P = 3-1/4"    W = 8"

### Rod Size

0 = Standard Rod  
 1 = Oversize Rod

### Options

AA = No Option  
 DA = Double Rod  
 EB = Silencer Bumpers  
 GA = High Temperature Rod Boot  
 LB = Low Breakaway  
 MA = Metallic Rod Scraper  
 MB = Rear Metallic Rod Scraper  
 PA = Polypak Rod Seal  
 PB = Rear Polypak Rod Seal  
 PP = Polypak Piston Seals  
 RA = Save Air Stroke Adjust  
 VA = FKM Seals  
 4D = Double Piston Stop Tube

### Cushion

N = No Cushion  
 B = Both Ends Cushioned  
 H = Head End Cushioned  
 C = Cap End Cushioned

Note: Options listed are ones that apply to a repair kit only.  
 Model number is set up to use option code supplied with original cylinder or with any above.

## How to Order - S Series Seal Kit

**S97 - K 1 N - AA**

### Type

S97 = S Series Repair Kit

### Bore

K = 1-1/2"    R = 4"  
 L = 2"        T = 5"  
 M = 2-1/2"    U = 6"  
 P = 3-1/4"    W = 8"

### Rod Size

0 = Standard Rod  
 1 = Oversize Rod

### Options

AA = No Option  
 DA = Double Rod  
 EB = Silencer Bumpers  
 GA = High Temperature Rod Boot  
 LB = Low Breakaway  
 MA = Metallic Rod Scraper  
 MB = Rear Metallic Rod Scraper  
 PA = Polypak Rod Seal  
 PB = Rear Polypak Rod Seal  
 PP = Polypak Piston Seals  
 RA = Save Air Stroke Adjust  
 VA = FKM Seals  
 4D = Double Piston Stop Tube

### Cushion

N = No Cushion  
 B = Both Ends Cushioned  
 H = Head End Cushioned  
 C = Cap End Cushioned

Note: Options listed are ones that apply to a repair kit only.  
 Model number is set up to use option code supplied with original cylinder or with any above.



## Piston Rod Assembly Kit Removal/Installation Instructions

1. Loosen 4 Acorn Nuts (Part #13) to remove Full Face Retainer (Part #11) and Piston/Rod Assembly (Part #19 & #20).
2. Carefully remove old seals and wearband (Part #15, #17, & #18). Any damage to the seal may result in leakage.
3. Lubricate piston seal(s) and Wearband (Part #15) with supplied Numatics' Lube. Examine seals before installing for any contamination. Contamination may cause leakage.
4. Install Piston Seal (Part #18). Make sure the piston seal is not twisted inside groove. Next install back-up rings (Part #17) if piston seal is a T-seal.
5. Install lubricated wearband onto piston. Sink piston/rod assembly into sinker tube. See Sinker Tube Part Numbers Chart.
6. Apply lube inside the cylinder tube.
7. Sink piston/rod assembly into cylinder tube.
8. Press piston/rod assembly flush with the cylinder tube. Wipe off any lube from the face of the piston.
9. Examine seals after installing for any contamination. Contamination may cause leakage.
10. Lightly grease Rod Seal (Part #3) of Loaded Bushing before installing. This will ease the installation of the rod bushing over the rod.
11. Assemble cylinder. Carefully place loaded bushing over the rod until getting interference. With a twisting motion, slide the bushing down onto the rod and into the bushing pocket on the head.
12. Place Full Face Retainer over bushing and loosely torque Acorn Nuts to allow head and cap to rotate slightly.
13. Before final torque, place cylinder on level surface to square head and cap. Torque Acorn Nuts in a crisscross pattern. Use the torque tolerance chart for Acorn Nuts.
14. Stroke cylinder by hand. This will enable detection of any binding. If binding does occur, repeat steps 12-14.

See Seal Installation Guide on page 27 for additional (visual) instructions.

## Repair and Seal Kit Removal/Installation Instructions

1. Loosen 4 Acorn Nuts (Part #13) to remove Full Face Retainer (Part #11), Loaded Bushing (Part # 5), and Piston/Rod Assembly (Part #19 & #20).
2. Carefully remove old seals and wearband (Part [#1, #2, #3 Seal Kit only], #8, #9, #10, #15, #17, & #18). Any damage to the seal grooves may result in leakage.
3. Lubricate new seals and Wearband (Part #15) with supplied Numatics' Lube. Examine seals before installing for any contamination. Contamination may cause leakage.
4. Install Piston Seal (Part #18). Make sure the piston seal is not twisted inside groove. Next install back-up rings (Part #17) if piston seal is a T-seal.
5. Install lubricated wearband onto piston. Sink piston/rod assembly into sinker tube. See Sinker Tube Part Numbers Chart.
6. Apply lube inside the cylinder tube.
7. Sink piston/rod assembly into cylinder tube.
8. Press piston/rod assembly flush with the cylinder tube. Wipe off any lube from the face of the piston.
9. Place Tube End Seals (Part #8) into head and cap seal grooves. Examine seals after installing for any contamination. Contamination may cause leakage.
10. Install Rod Wiper (Part #1), Bushing O-ring (Part #2), and Rod Seal (Part #3) into bushing (Seal Kit only). Lightly grease Rod Seal and Bushing O-ring after installation. This will ease the installation of the rod bushing over the rod and into the head.
11. Assemble cylinder. Carefully place loaded bushing over the rod until getting interference. With a twisting motion, slide the bushing down onto the rod and into the bushing pocket on the head.
12. Place Full Face Retainer over bushing and loosely torque Acorn Nuts to allow head and cap to rotate slightly.
13. Before final torque, place cylinder on level surface to square head and cap. Torque Acorn Nuts in a crisscross pattern. Use the torque tolerance chart for Acorn Nuts.
14. Stroke cylinder by hand. This will enable detection of any binding. If binding does occur, repeat steps 12-14.

See Seal Installation Guide on page 27 for additional (visual) instructions.

## Diagrams

Pneumatic Service Temperatures:  
 Nitrile Seals: -10°F (-23°C) to 165°F (74°C)  
 FKM Seals: 0°F (-17°C) to 400°F (204°C)

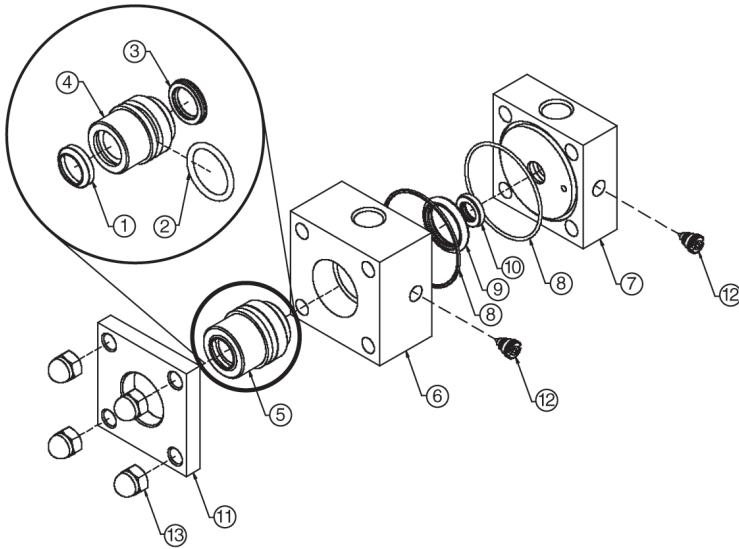

Head, Cap, and Bushing Assembly

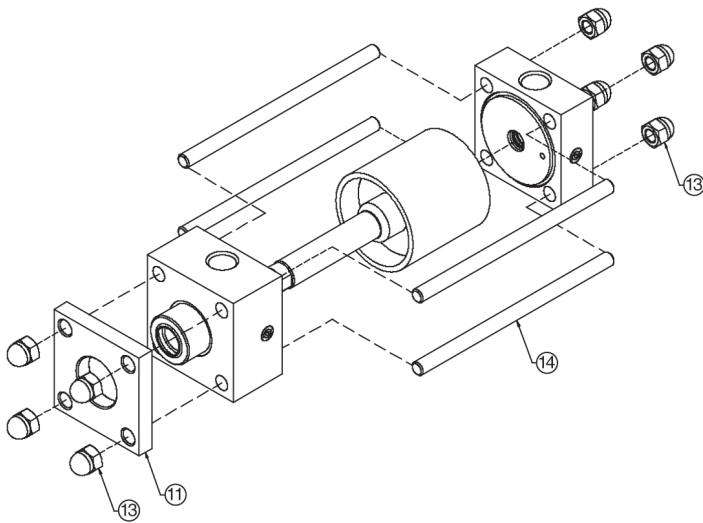

Cylinder Assembly and Tie Rod Torque

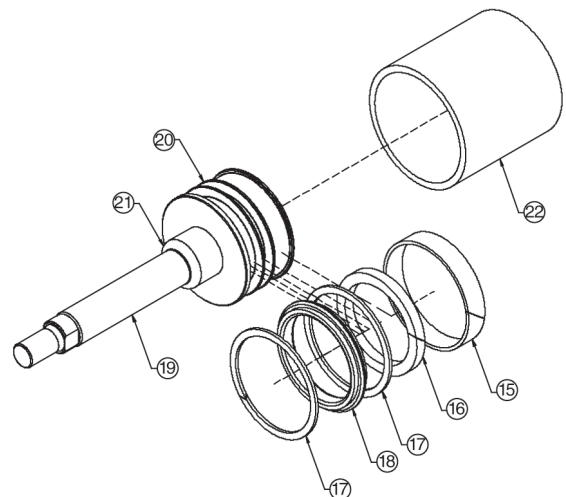

Piston/Rod Assembly

## S Series

Part #	Description	Parts included in:		
		Seal Kit	Repair Kit	Piston/Rod Assembly
1	Rod Wiper	X		
2	Bushing O-ring	X		
3	Rod Seal	X		
4	Bushing			
5	Loaded Bushing Assembly		X	
6	Head			
7	Cap			
8	Tube End Seals	X	X	
9	Head Cushion Seal	X	X	
10	Cap Cushion Seal	X	X	
11	Bushing Retainer			
12	Cushion Needle			
13	Acorn Hex Nuts			
14	Tie Rods			
15	Wearband	X	X	
16	Magnet			X
17	Back-up Rings	X	X	
18	Piston Seal	X	X	
19	Rod			X
20	Piston			X
21	Head Cushion Spear			
22	Tube			X

## Seal Installation Guide

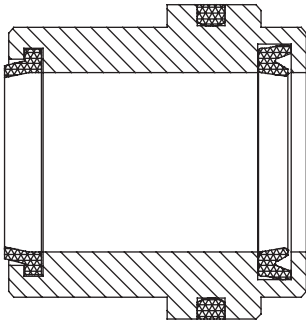

Loaded Bushing

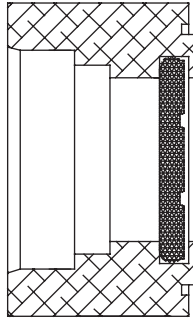

Cushioned Head or Cap

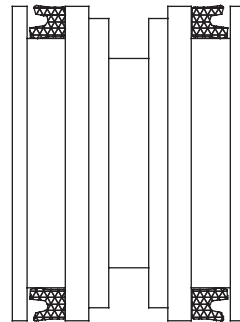

Low Breakaway Piston

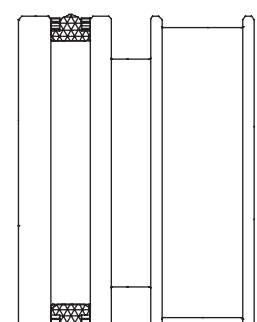

T-Seal Piston

### Tie Rod Nut Torque Tolerances (lbs-ft) Part #13

Bore	Min.	Max.
1-1/2"	8	10
2"	15	20
2-1/2"	15	20
3-1/4"	23	30
4"	23	30
5"	50	60
6"	50	60
8"	80	90

### Sinker Tube Part Numbers

Bore	Part #
1-1/2"	A06-K91
2"	A06-L91
2-1/2"	A06-M91
3-1/4"	A06-P91
4"	A06-R91
5"	A06-T91
6"	A06-U91
8"	A06-W91

**Note:** Sinker Tubes are not included in kits. They can be ordered using the part numbers from the provided chart.



World Class Supplier of Pneumatic Components



## World Headquarters

### **USA Numatics, Incorporated**

46280 Dylan Drive  
Novi, Michigan 48377

P: 248-596-3200  
F: 248-596-3201

### **Canada Numatics, Ltd**

P: 519-758-2700  
F: 519-758-5540

### **México - Ascomatica SA de CV**

P: 52 55 58 09 56 40 (DF y Area metropolitana)  
P: 01 800 000 ASCO (2726) (Interior de la República)  
F: 52 55 58 09 56 60

### **Brazil Ascoval Ind.e Comercio Ltda**

P: (55) 11-4208-1700  
F: (55) 11-4195-3970