

GasPro™ TEM-2100/3100

High Flow PTFE In-Line Filter Assemblies



GasPro™ TEM-2100/3100 Series filters are designed for the filtration of semiconductor grade inert gases and CDA (clean dry air). This all-welded in-line multi-tube assembly will deliver 3 µm particle retention where high flow rate is required and space is limited.

These filter assemblies can easily be designed inside a cabinet, be placed under the cleanroom floor or anywhere in the subfab.

A PTFE membrane and polypropylene supported cartridge is enclosed in a 316L stainless steel electro-polished welded housing. Final assembly is purged with filtered nitrogen for initial cleanliness.

Applications

- General and process inert facilities gases for semiconductor, flat panel display, and other high-purity applications.
- Microelectronics clean dry air.

** In CDA and other facility gas filtration applications, flow, temperature, particle challenge, and other differences unique to each system, can affect overall filtration performance, and may affect the useful filtration period for each filter.*

In elevated CDA temperatures (50-69°C / 122-156°F), recommended filter change-out is one year after installation. Between 70-80°C / 158-176°F, the recommended change-out is 6 months after installation. Filter lifetime can vary due to flow, particle challenge and other differences which are unique to each system, so it is up to the user to verify product life within their system process.

Specifications

- **Filtration rating**
Our porous ePTFE filters provide efficient 3 nm particle retention.
- **Maximum operating temperature***
80°C (176°F).
Recommended changeout:
6 months when operating above 69°C (156°F).
- **Maximum operating pressure**
17.2 bar (250 psig) @ 20°C (68°F).
- **Maximum forward flow differential pressure**
20°C (68°F): 6.0 bar (87 psi)
80°C (176°F): 4.0 bar (58 psi)

Features and Benefits

- **Electro-polished housing**
The filter assemblies have a 15Ra electro-polished 316L stainless steel housing to prevent corrosion and particle build up on interior surfaces.
- **Out of package cleanliness**
Our GasPro™ TEM-2100/3100 filters are cleaned and packaged in a cleanroom with organic free handling for out-of-package particulate and chemical free cleanliness. Final assembly is purged with filtrated nitrogen for initial cleanliness. Additional preconditioning is optional.
- **Multiple fitting options for ease of installation**
Standard fitting options include face / gasket seal, compression, butt weld and NPT. Special fittings, including tri-clamp (clover) sanitary and flange type may be available upon request.
- **100% helium leak tested**
All units are tested to 1x10⁻⁹ atm cc/second.

PFG934/July 2019/Rev22/Oct2021

Contact Information: UK, New Milton Division
Tel: +44 (0) 1425 612010
info@porvairfiltration.com

US, Boise Division
Tel: +1 208 461 2090
infoUS@porvairfiltration.com

India, Mumbai Division
Tel: +91 22 2081 1148
infoIN@porvairfiltration.com

Specifications

TEM-2150-48 3" butt weld

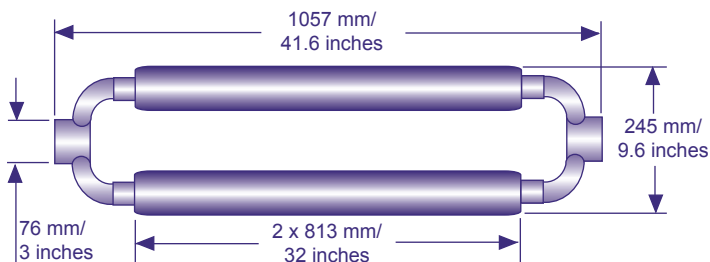

TEM-2160-32TCKA 2" Tri-Clover

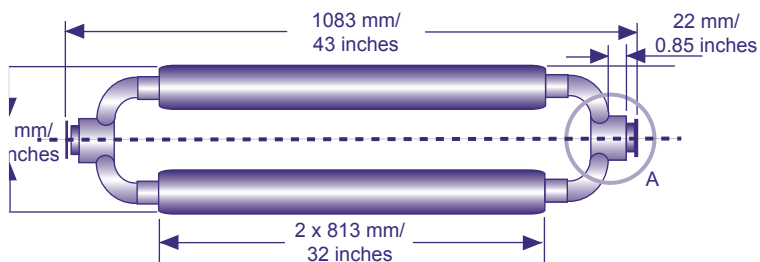

TEM-3150-32 2" butt weld

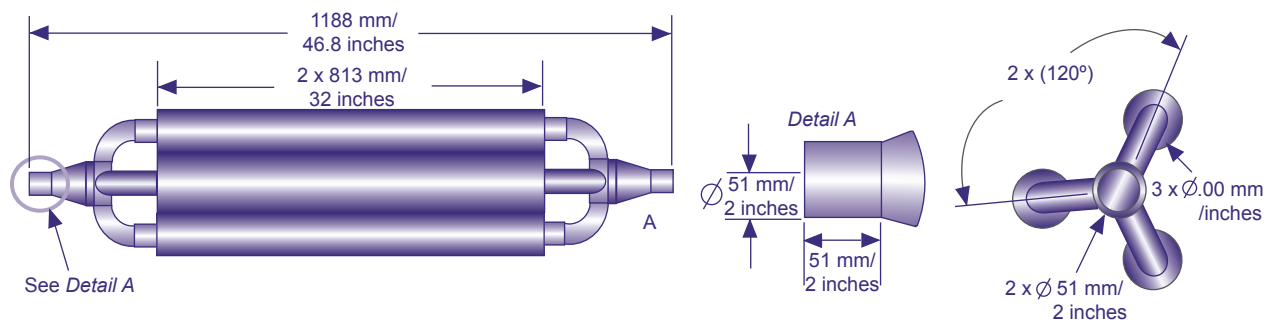

TEM-3150-48 3" butt weld

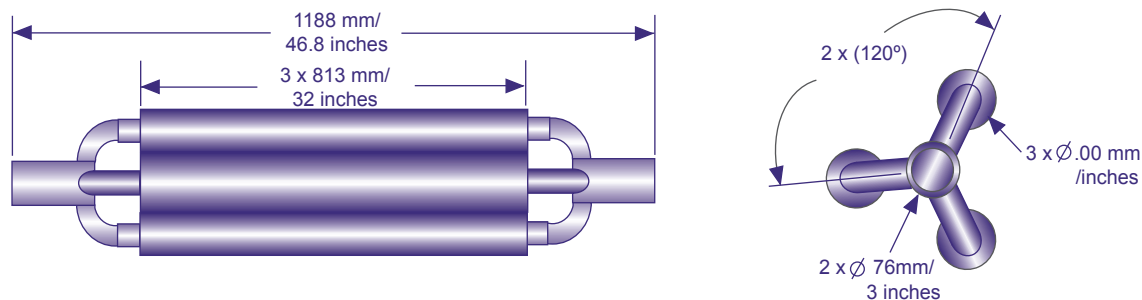

TEM-3360-32KF 2" flange

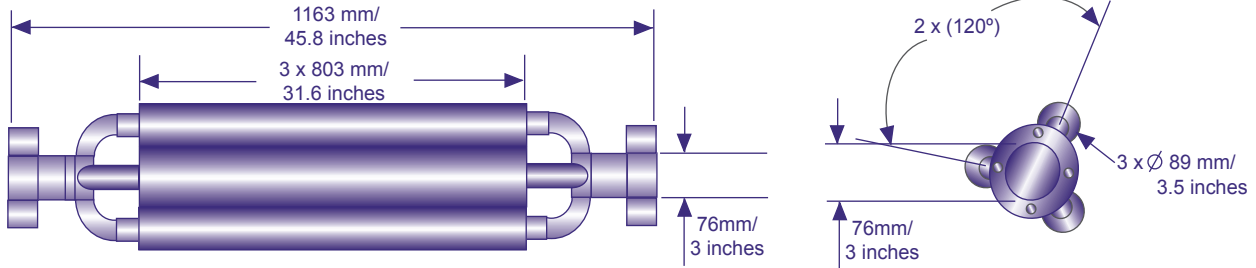

TEM-2100 series

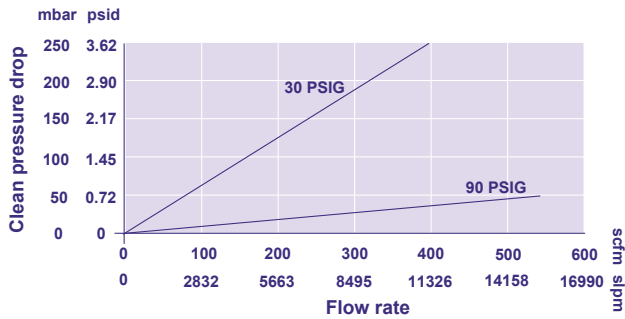

TEM-3100 series

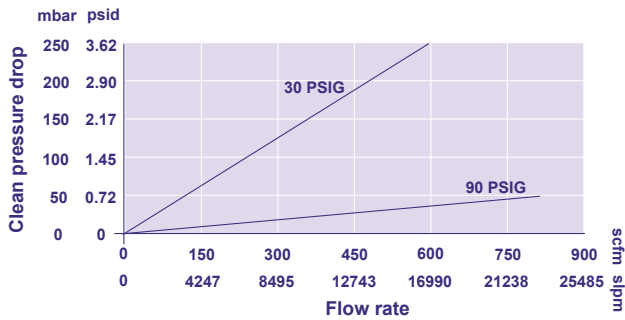

TEM-2100/3100 Part Numbers and Ordering Information

Part number	Inlet/outlet fittings	Filter media/housing	Other materials	Length (L)
TEM-2150-48	3" butt weld inlet/outlet	PTFE / 316L Stainless Steel	Polypropylene Viton® seal*	1057.1 mm (41.62")
TEM-2160-32TCK	2" Tri-Colver (Clamp) inlet/outlet			1088.6 mm (42.86")
TEM-3150-32	2" butt weld inlet/outlet			1188 mm (46.77")
TEM-3150-48	3" butt weld inlet/outlet			1188 mm (46.77")
TEM-3360-32KF	2" KF flange inlet/outlet			1163 mm (45.80")

* FEP encapsulated FKM O-rings are available upon request

Not all fittings, lengths, and part numbers are shown on the chart. Please contact your Porvair representative or an approved Porvair distributor for special length and fitting options.