

# ASCO™ High-Flow Valves for Harsh Environments

Solenoid Piloted-Spring Return | 1/4" - 1/2" NPT

3/2  
SERIES  
381

## Features

- Ideal for use in extremely harsh and corrosive environments, such as those found on offshore and near-shore oil platforms
- High-flow design results in faster process response time
- Broad operating temperature range of -60°C to 80°C allows for use in extreme environmental conditions
- Requires zero main pressure to operate when using the externally piloted version
- Compatible with speed control, allowing users to control flow to prevent abrupt opening/closing of actuator
- Rated for air, inert gas, and sweet dry natural gas

## Construction

Valve Parts in Contact with Fluids	
Body	316L Stainless Steel
O-rings   Disc	Low Temperature NBR
Dynamic O-ring	Low Temperature FKM
U-Cup Seal	FVM, PTFE
Core and Plugnut	430F Stainless Steel
Sleeve	304L Stainless Steel
Piston	303, 316L Stainless Steel
Spring	17-7 Stainless Steel
Poppets   Stem   Disc Retainer	303 Stainless Steel
Screws	316 Stainless Steel
Core Guide (10.1 & 11.6W)	POM
Core Tube (10.1 & 11.6W)	305 Stainless Steel
Shading Coil (10.1 & 11.6W)	Silver

## Electrical

Solenoid Options	Insulation Class	Wattage	Spare Coil Part Number
Intrinsically Safe	H	0.48 W	298006
Ultra Low Power Explosionproof	F/H	0.55/0.7 W	274714/274914
Ultra Low Power General Purpose	F/H	0.55/0.7 W	238710/238910
Ultra Low Power DIN	F	0.55 W	238712
Intrinsically Safe DIN	H	0.48 W	298008
Electronically Enhanced General Purpose	H	1.2 to 1.5 W	250404
Electronically Enhanced Explosion Proof Div. 2	H	1.2 to 1.5 W	250504
Standard Low Power	F/H	1.4 W/1.8 W	274714/274914
Compact Low Power	F	1.8 W	437962
Standard AC	F/H	10.1 W	274614/274814
Standard DC	F/H	11.6 W	274714/274914
Stainless Steel Encapsulated	F	1.8 W	505434
Surge Suppression ①	F/F/H	0.75/1.7/2.0 W	276007/276007/523130

Note: ① Surge suppression contains diode bridge.  
For Supervisory & leakage current information see next page.

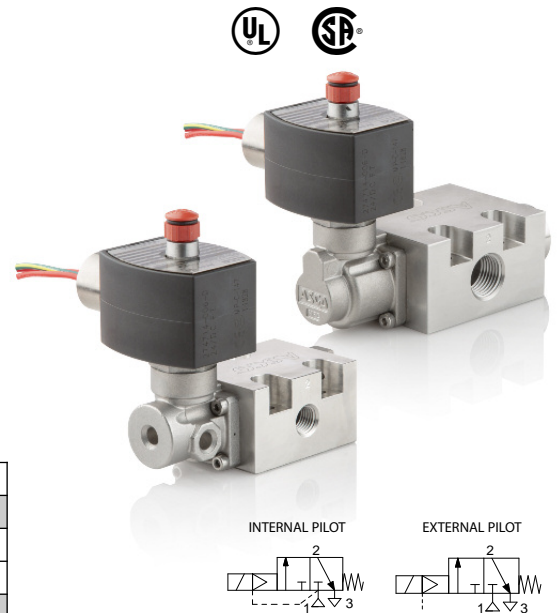

## Solenoid Enclosures

**Standard:** Explosionproof and Watertight, Types 1, 2, 3, 3S, 4, 4X, 6, and 6P. (Depending on solenoid)  
*Refer to Engineering Section for fluid and temperature compatibility.*

## Approvals

### Solenoid Only:

- UL and CSA certified for Class I, Div. 1 and Class II, Div. 1 locations
- UL and CSA certified for Class I, Div. 2 and Class II, Div. 2 (Explosion-Proof Electronically Enhanced voltage ranging and JS2D Junction Box)
- ATEX, IECEx: Ex db mb - All Solenoid except Compact Low Power, Intrinsically Safe, and Stainless Steel Encapsulated
- ATEX, IECEx: Ex db - Stainless Steel Encapsulated Solenoid
- ATEX, IECEx: Ex eb mb - JS2D Junction Box
- FM, CSA, Class I, Div. 1 and ATEX/IECEx ia Intrinsically Safe
- SIL 3 Capable options

*Refer to Engineering for details.*

## Entity Parameters

### Intrinsically Safe - 0.48 W:

$V_{max} = 32 \text{ VDC}$     $C_i = 0 \text{ nF}$     $P_i = 1.5 \text{ W}$   
 $I_{max} = 500 \text{ mA}$     $L_i = 0 \text{ H}$











SPECIAL SERVICE  
PILOT

## Supervisory & leakage current

**IMPORTANT:** Supervisory & leakage current above the drop out current listed will cause improper operation. Consult your local ASCO sales office for additional assistance.

Description	Wattage	Voltage (DC)	Min. Pull In (mA)	Drop Out (mA)	Coil Resistance at 68° F (20° C) (Ohms)
Ultra Low Power	0.55 W	12V	34.0	3.63	255
		24V	17.0	1.80	1025
		48V	8.5	0.91	4080
		125V	3.2	0.34	27,400
Standard Low Power	1.4 W	12 V	83.5	13.9	102
		24 V	42.0	7.0	410
Compact Low Power	1.8 W	12 V	95.0	20.0	80
		24 V	47.0	10.0	320
Stainless Steel Encapsulated	1.8 W	12 V	99.0	18.0	80
		24 V	47.0	10.0	320

## Solenoid Derivatives

Solenoid Operator		Watts		Ambient Temp./Fluid AC		Ambient Temp./Fluid DC	
		AC	DC	Min. °F (°C)	Max. °F (°C)	Min. °F (°C)	Max. °F (°C)
<b>Solenoid</b>							
	<b>EV</b> Explosion-Proof Solenoid	10.1	11.6 1.4 1.7* 0.55 0.75*	-76 (-60)	125 (52)	-76 (-60)	131 (55) For 11.6 W 140 (60) For 1.4 W and 1.7 W 149 (65) For 0.55 W and 0.75 W
	<b>EVHT</b> High Temperature Explosion-Proof Solenoid	10.1	11.6 2.0* 1.8 0.7	-76 (-60)	140 (60)	-76 (-60)	131 (55) For 11.6 W 176 (80) For 1.8 W and 2.0 W ② 176 (80) For 0.7 W
	<b>Compact Low Power</b>	-	1.8	-	-	-58 (-50)	176 (80)
	<b>Intrinsically Safe (IS)</b> (Conduit)	-	0.48	-	-	-40 (-40)	149 (65)
	<b>Electronically Enhanced Voltage Ranging</b> Explosion-Proof - Div. 2	1.2 to 1.5	1.2 to 1.5	140 (60) - Max -40 (-40) - Min			
	<b>Intrinsically Safe DIN (ISSC)</b>	-	0.48	-	-	-40 (-40)	149 (65)
	<b>Stainless Steel Encapsulated 22mm coil</b> Explosion-Proof, Div. 1	-	1.8	-	-	-13 (-25)	176 (80)
<b>Enclosures</b>							
	<b>JS2D</b> Class I, Div. 2 Junction Box	10.1	11.6 1.4 1.7* 0.55 0.75	-13 (-25)	125 (52)	-13 (-25) ③ -40 (-40) ④	115 (46) (ATEX, IECEx) & 131 (55) (UL, CSA) For 11.6 W 140 (60) For 1.4 W and 1.7 W 149 (65) For 0.55 W and 0.75 W
	<b>JSIS</b> Intrinsically Safe - Class I, Div. 1 & 2 Junction Box	-	0.48	-	-	-40 (-40)	149 (65)
	<b>JBEF</b> Class I, Div. 1 Junction Box	10.1	11.6 1.4 1.7* 0.55 0.75*	-40 (-40)	125 (52)	-40 (-40)	131 (55) For 11.6 W 140 (60) For 1.4 W and 1.7 W 149 (65) For 0.55 W
	<b>JBEFHT</b> Class I, Div. 1 (Class H) High-Temperature Junction Box	10.1	11.6 2.0* 1.8 0.7	-40 (-40)	140 (60)	-40 (-40)	131 (55) For 11.6 W 176 (80) For 1.8 W and 2.0 W 176 (80) For 0.7 W

① 1/4" brass valves with FKM limited to 5°F (-15°C); not available with LTNBR. ② 165 (74) (ATEX, IECEx) for LTNBR versions only. ③ For ATEX, IECEx applications. ④ For UL/CSA Division 2.  
FKM - Standard version with FKM seals; LTNBR - Low Temperature NBR version. \* Surge suppression.  
**Note:** For additional constructions, please visit the 381 configurator at [www.asco.com](http://www.asco.com).



SPECIAL SERVICE  
PILOT

## How to order

8381L001 H1 400 F1

Base Catalog Number

See Specifications Table

Coil Connection Type

See configurator at [www.asco.com](http://www.asco.com)

## Specifications English units (Metric)

Pipe Size (in)	Flow Factor Cv (Kv)	Pilot Pressure psi (bar)		Operating Pressure Differential psi (bar)		Base Catalog Number	Const. Ref.	Max. Fluid Temp. °F (°C)	Watt Rating	
		Min.	Max.	Min. ①	Max.				AC	DC
<b>Normally Closed, Single Solenoid/Spring Return - Internally Piloted</b>										
1/4	2.2 (1.9)	-	-	25 (1.7)	150 (10.3)	8381L001	1	Refer to Solenoid Table	10.1	11.6
1/4	2.2 (1.9)	-	-	25 (1.7)	150 (10.3)	8381L311	1		-	1.4/1.7
1/4	2.2 (1.9)	-	-	25 (1.7)	150 (10.3)	8381L321	1		-	1.8
1/4	2.2 (1.9)	-	-	25 (1.7)	130 (9)	8381L331	1		-	0.55/0.75
1/4	2.2 (1.9)	-	-	25 (1.7)	130 (9)	8381L341	1		-	0.7
1/4	2.2 (1.9)	-	-	25 (1.7)	130 (9)	8381L361	1		-	0.48
1/4	2.2 (1.9)	-	-	25 (1.7)	150 (10.3)	8381L371	1		1.5	1.2
1/4	2.2 (1.9)	-	-	25 (1.7)	150 (10.3)	8381L381	3		-	1.8 ②
1/4	2.2 (1.9)	-	-	25 (1.7)	150 (10.3)	8381L391	5		-	1.8 ③
3/8	2.6 (2.2)	-	-	25 (1.7)	150 (10.3)	8381L003	1		10.1	11.6
3/8	2.6 (2.2)	-	-	25 (1.7)	150 (10.3)	8381L313	1		-	1.4/1.7
3/8	2.6 (2.2)	-	-	25 (1.7)	150 (10.3)	8381L323	1		-	1.8
3/8	2.6 (2.2)	-	-	25 (1.7)	130 (9)	8381L333	1		-	0.55/0.75
3/8	2.6 (2.2)	-	-	25 (1.7)	130 (9)	8381L343	1		-	0.7
3/8	2.6 (2.2)	-	-	25 (1.7)	130 (9)	8381L363	1		-	0.48
3/8	2.6 (2.2)	-	-	25 (1.7)	150 (10.3)	8381L373	1		1.5	1.2
3/8	2.6 (2.2)	-	-	25 (1.7)	150 (10.3)	8381L383	3		-	1.8 ②
3/8	2.6 (2.2)	-	-	25 (1.7)	150 (10.3)	8381L393	5		-	1.8 ③
3/8 High Flow	4.8 (4.1)	-	-	25 (1.7)	150 (10.3)	8381L005	2		10.1	11.6
3/8 High Flow	4.8 (4.1)	-	-	25 (1.7)	150 (10.3)	8381L315	2		-	1.4/1.7
3/8 High Flow	4.8 (4.1)	-	-	25 (1.7)	150 (10.3)	8381L325	2		-	1.8
3/8 High Flow	4.8 (4.1)	-	-	25 (1.7)	130 (9)	8381L335	2		-	0.55/0.75
3/8 High Flow	4.8 (4.1)	-	-	25 (1.7)	130 (9)	8381L345	2		-	0.7
3/8 High Flow	4.8 (4.1)	-	-	25 (1.7)	130 (9)	8381L365	2		-	0.48
3/8 High Flow	4.8 (4.1)	-	-	25 (1.7)	150 (10.3)	8381L375	2		1.5	1.2
3/8 High Flow	4.8 (4.1)	-	-	25 (1.7)	150 (10.3)	8381L385	4		-	1.8 ②
3/8 High Flow	4.8 (4.1)	-	-	25 (1.7)	150 (10.3)	8381L395	6		-	1.8 ③
1/2	6.2 (5.3)	-	-	25 (1.7)	150 (10.3)	8381L007	2		10.1	11.6
1/2	6.2 (5.3)	-	-	25 (1.7)	150 (10.3)	8381L317	2		-	1.4/1.7
1/2	6.2 (5.3)	-	-	25 (1.7)	150 (10.3)	8381L327	2		-	1.8
1/2	6.2 (5.3)	-	-	25 (1.7)	130 (9)	8381L337	2		-	0.55/0.75
1/2	6.2 (5.3)	-	-	25 (1.7)	130 (9)	8381L347	2		-	0.7
1/2	6.2 (5.3)	-	-	25 (1.7)	130 (9)	8381L367	2		-	0.48
1/2	6.2 (5.3)	-	-	25 (1.7)	150 (10.3)	8381L377	2	1.5	1.2	
1/2	6.2 (5.3)	-	-	25 (1.7)	150 (10.3)	8381L387	4	-	1.8 ②	
1/2	6.2 (5.3)	-	-	25 (1.7)	150 (10.3)	8381L397	6	-	1.8 ③	

Note: ① See graph for Pilot Pressure. ② 22mm stainless steel encapsulated coil. ③ Subminiature coil.

SPECIAL SERVICE PILOT

**Specifications English units (Metric)**

Pipe Size (in)	Flow Factor Cv (Kv)	Pilot Pressure psi (bar)		Operating Pressure Differential psi (bar)		Base Catalog Number	Const. Ref.	Max. Fluid Temp. °F (°C)	Watt Rating	
		Min.	Max.	Min. ①	Max.				AC	DC
<b>Normally Closed, Single Solenoid/Spring Return - Externally Piloted</b>										
1/4	2.2 (1.9)	25 (1.7)	150 (10.3)	0	200 (13.8)	8381L002	1	Refer to Solenoid Table	10.1	11.6
1/4	2.2 (1.9)	25 (1.7)	150 (10.3)	0	200 (13.8)	8381L312	1		-	1.4/1.7
1/4	2.2 (1.9)	25 (1.7)	150 (10.3)	0	200 (13.8)	8381L322	1		-	1.8
1/4	2.2 (1.9)	25 (1.7)	130 (9)	0	200 (13.8)	8381L332	1		-	0.55/0.75
1/4	2.2 (1.9)	25 (1.7)	130 (9)	0	200 (13.8)	8381L342	1		-	0.7
1/4	2.2 (1.9)	25 (1.7)	130 (9)	0	200 (13.8)	8381L362	1		-	0.48
1/4	2.2 (1.9)	25 (1.7)	150 (10.3)	0	200 (13.8)	8381L372	1		1.5	1.2
1/4	2.2 (1.9)	25 (1.7)	150 (10.3)	0	200 (13.8)	8381L382	3		-	1.8 ②
1/4	2.2 (1.9)	25 (1.7)	150 (10.3)	0	200 (13.8)	8381L392	5		-	1.8 ③
3/8	2.6 (2.2)	25 (1.7)	150 (10.3)	0	200 (13.8)	8381L004	1		10.1	11.6
3/8	2.6 (2.2)	25 (1.7)	150 (10.3)	0	200 (13.8)	8381L314	1		-	1.4/1.7
3/8	2.6 (2.2)	25 (1.7)	150 (10.3)	0	200 (13.8)	8381L324	1		-	1.8
3/8	2.6 (2.2)	25 (1.7)	130 (9)	0	200 (13.8)	8381L334	1		-	0.55/0.75
3/8	2.6 (2.2)	25 (1.7)	130 (9)	0	200 (13.8)	8381L344	1		-	0.7
3/8	2.6 (2.2)	25 (1.7)	130 (9)	0	200 (13.8)	8381L364	1		-	0.48
3/8	2.6 (2.2)	25 (1.7)	150 (10.3)	0	200 (13.8)	8381L374	1		1.5	1.2
3/8	2.6 (2.2)	25 (1.7)	150 (10.3)	0	200 (13.8)	8381L384	3		-	1.8 ②
3/8	2.6 (2.2)	25 (1.7)	150 (10.3)	0	200 (13.8)	8381L394	5		-	1.8 ③
3/8 High Flow	4.8 (4.1)	25 (1.7)	150 (10.3)	0	200 (13.8)	8381L006	2		10.1	11.6
3/8 High Flow	4.8 (4.1)	25 (1.7)	150 (10.3)	0	200 (13.8)	8381L316	2		-	1.4/1.7
3/8 High Flow	4.8 (4.1)	25 (1.7)	150 (10.3)	0	200 (13.8)	8381L326	2		-	1.8
3/8 High Flow	4.8 (4.1)	25 (1.7)	130 (9)	0	200 (13.8)	8381L336	2		-	0.55/0.75
3/8 High Flow	4.8 (4.1)	25 (1.7)	130 (9)	0	200 (13.8)	8381L346	2		-	0.7
3/8 High Flow	4.8 (4.1)	25 (1.7)	130 (9)	0	200 (13.8)	8381L366	2		-	0.48
3/8 High Flow	4.8 (4.1)	25 (1.7)	150 (10.3)	0	200 (13.8)	8381L376	2		1.5	1.2
3/8 High Flow	4.8 (4.1)	25 (1.7)	150 (10.3)	0	200 (13.8)	8381L386	4		-	1.8 ②
3/8 High Flow	4.8 (4.1)	27 (1.7)	152 (10.3)	2	200 (13.8)	8381L396	6		-	1.8 ③
1/2	6.2 (5.3)	25 (1.7)	150 (10.3)	0	200 (13.8)	8381L008	2		10.1	11.6
1/2	6.2 (5.3)	25 (1.7)	150 (10.3)	0	200 (13.8)	8381L318	2		-	1.4/1.7
1/2	6.2 (5.3)	25 (1.7)	150 (10.3)	0	200 (13.8)	8381L328	2		-	0.48
1/2	6.2 (5.3)	25 (1.7)	130 (9)	0	200 (13.8)	8381L338	2	-	0.55/0.75	
1/2	6.2 (5.3)	25 (1.7)	130 (9)	0	200 (13.8)	8381L348	2	-	0.7	
1/2	6.2 (5.3)	25 (1.7)	130 (9)	0	200 (13.8)	8381L368	2	-	0.48	
1/2	6.2 (5.3)	25 (1.7)	150 (10.3)	0	200 (13.8)	8381L378	2	1.5	1.2	
1/2	6.2 (5.3)	25 (1.7)	150 (10.3)	0	200 (13.8)	8381L388	4	-	1.8 ②	
1/2	6.2 (5.3)	25 (1.7)	150 (10.3)	0	200 (13.8)	8381L398	6	-	1.8 ③	

Note: ① See graph for Pilot Pressure. ② 22mm stainless steel encapsulated coil. ③ Subminiature coil.

**Note:** These charts are for reference only. The final Auxiliary pilot pressure may need to be increased dependent upon specific installation conditions and temperature extremes. Operating at temperature extremes may require an Auxiliary pressure greater than what is shown in the chart, up to the maximum, shown on the valve nameplate.

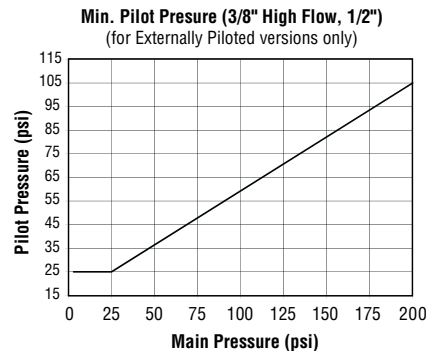
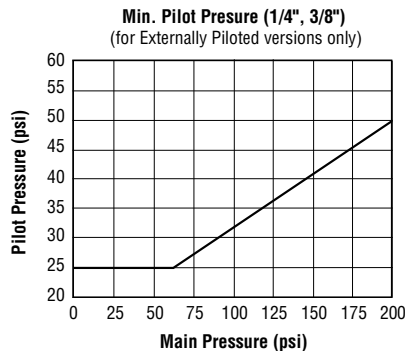



# 3/2 SERIES 381

## Dimensions English units (Metric)

### Const. Ref. 3

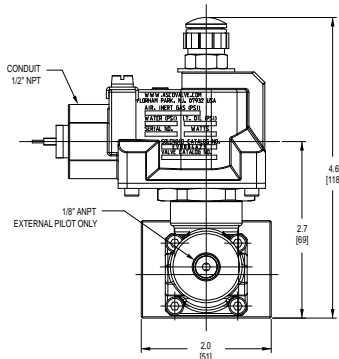
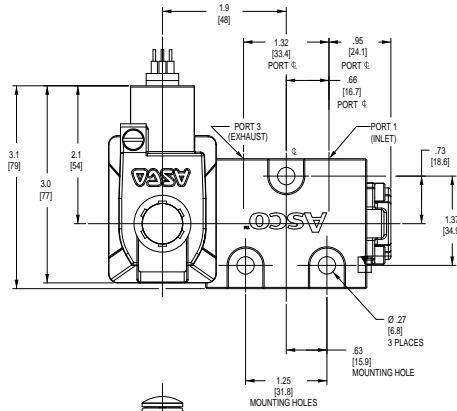

SPECIAL SERVICE  
PILOT

### Const. Ref. 4

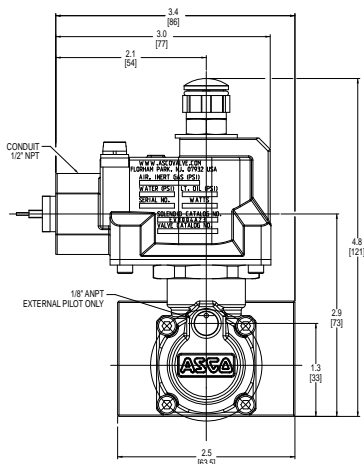
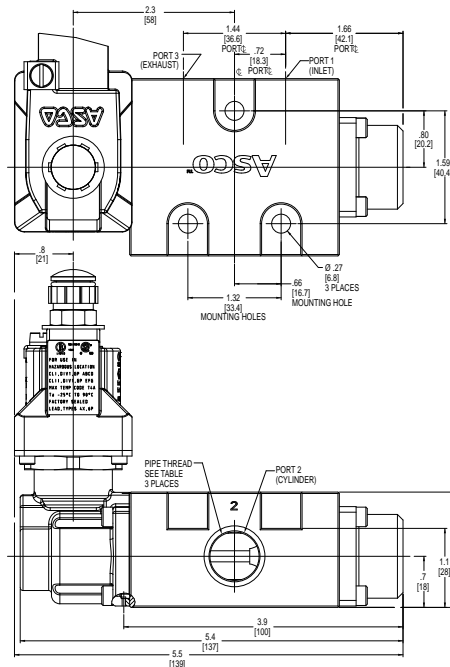

Dimensions English units (Metric)

Const. Ref. 5

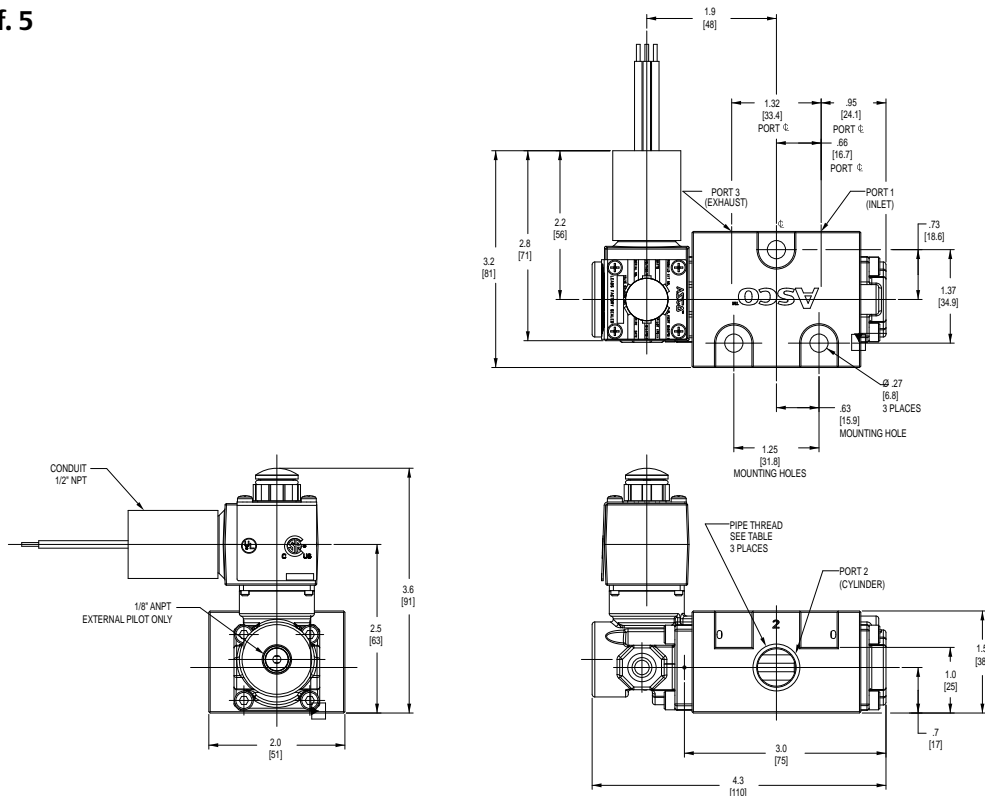

Const. Ref. 6

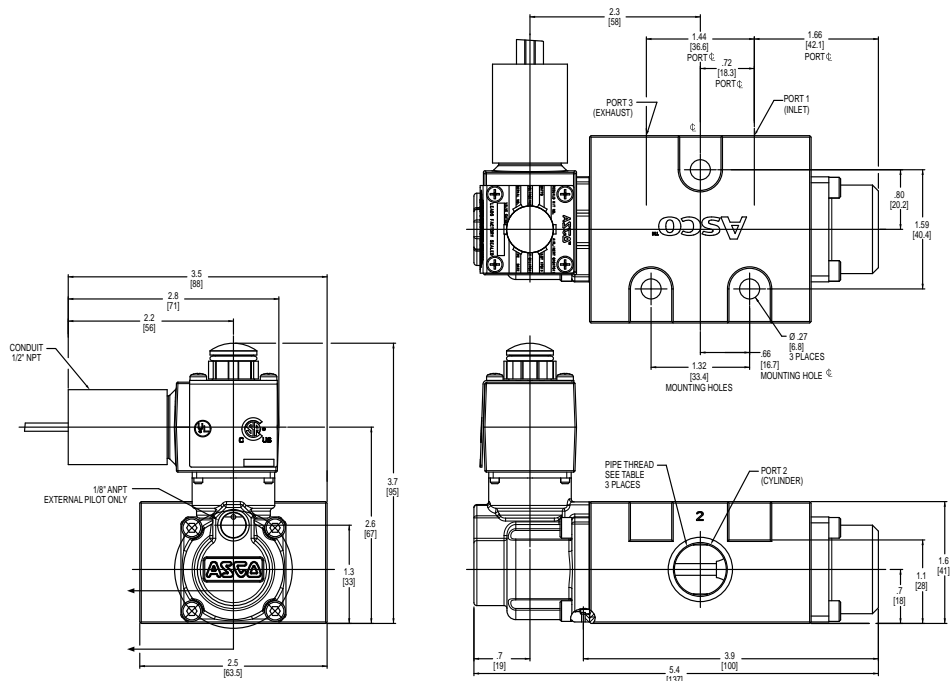

SPECIAL SERVICE  
PILOT