

ASCO™ MINIATURE SOLENOID VALVES

GENERAL SERVICE VALVES

SERIES
L123 / L257 / L323

- Direct acting solenoid valve.
- Suitable to shut off liquid and gaseous fluids; suitable for low pressure steam and applications in sterilising autoclaves (verify the compatibility of materials with fluids in contact).
- Typical applications include
 - Dental equipment
 - Steam sterilizers
 - Bio-medical analyzers
 - Low pressure steam

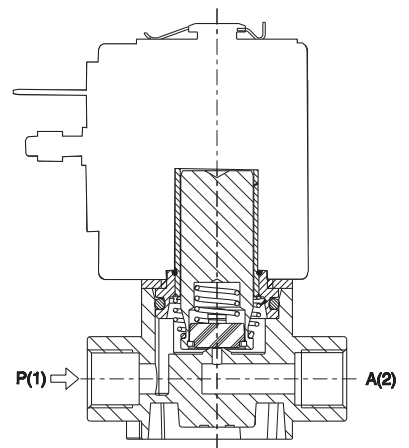
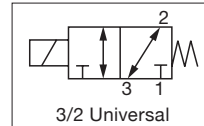
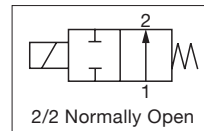
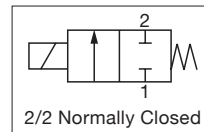

General Valve Information	
Body	PPS
Seals*	FKM
Internal Components	Stainless Steel Stainless Steel and PPS
Seat	PPS
Core Tube	Stainless Steel
Shading coil	Copper
Fluids	Liquids or gases
Fluid temperature	0°C +130°C
Differential pressure	see "Specifications" [1 bar = 100 kPa]
Response time	~ 20ms
Max. Viscosity	37 cSt (mm ² /s)

* Ensure that the compatibility of the materials in contact with the fluids is verified

Electrical Characteristics					
	ZA10A (UL class F - for UL cl.H: ZA34 (E153691))	ZA10B (UL class F - for UL cl.H: ZA34 (E153691))	ZA10G (UL class F - for UL cl.H: ZA34 (E153691))		
Continuous duty	ED 100%	ED 100%	ED 100%		
Coil Insulation Class	F (155°C) on request class H (180°C)	F (155°C)	F (155°C) on request class H (180°C)		
Connector	DIN 46340 - 3 pole connector (EN175301-803)	DIN 46340 - 3 pole connector (EN175301-803)	DIN 46340 - 3 pole connector (EN175301-803)		
Encapsulation material	PPS (polyphenylsulfure) fiberglass reinforced	PET (polyethylene-terephthalate) fiberglass reinforced	PPS (polyphenylsulfure) fiberglass reinforced		
Electrical Enclosure Protection	IP67 (EN60529) with plug connector	IP65 (EN60529) with plug connector	IP67 (EN60529) with plug connector		
Standard Voltages*	DC	12-24 V (+10% -5%)	24V (+10% -5%) (UL)	12-24 V (+10% -5%)	
	AC	24V/50Hz - 110V/50Hz (120V/60Hz) - 230V/50Hz (+10% -15%)			

* other voltages and frequencies on request

01094GB-2019-R01

Specifications																					
Pipe Connection	Orifice Size	Flow Coefficient		Operating Pressure, bar				Power Rating (W)			Catalog Number		Sealing Materials*	Notes							
				min.	max.				AC (VA)		DC (W)	Threaded Body									
					Gases		Liquids		Inrush	Holding					Coil						
					AC	DC	AC	DC													
mm	Kv (m ³ /h)	Cv																			
2/2 NC - Normally Closed																					
G1/8	1.6	0.09	0.10	0	10	10	10	10	23	14	9	L123V01	ZA10A	FKM	1,2,3						
	2.3	0.15	0.17		10	10	10	10													
	3.2	0.25	0.29		10	4	10	4													
Barbed ports	1.6	0.09	0.10		10	10	10	10				L123V02			2,3						
	2.3	0.15	0.17		10	10	10	10													
	3.2	0.25	0.29		10	4	10	4													
Barbed ports with ring nut	1.6	0.09	0.10		10	10	10	10				L123V03			2,3,4						
	2.3	0.15	0.17		10	10	10	10													
	3.2	0.25	0.29		10	4	10	4													
Barbed ports	2.3	0.15	0.17		10	10	10	10				L132V04			3,5						
	3.2	0.25	0.29		10	4	10	4													
2/2 NO - Normally Open																					
G1/8	3	0.18	0.21	0	3	3	3	3	23	14	9	L257V02	ZA10A	FKM	1, 3,5						
Barbed ports												L257V01				2,3					
Barbed ports with ring nut		L257V03	2,3,4																		
G1/4	4.2	0.33			0.38	2.5	2.5	2.5				2.5			23	14	10	L257V04	ZA10A	1,3	
			2.5			2.5	2.5	2.5				23			14	10	L257V05	ZA10B			
Barbed ports		0.26	0.30		2.5	2.5	2.5	2.5				23			14	10	L257V05	ZA10A	3		
					2.5	2.5	2.5	2.5				23			14	10	L257V05	ZA10B			
Barbed ports		2.5	0.14		0.16	5	5	5				5			23	14	9	L257V06	ZA10A		2,3
		3	0.18		0.21	3	3	3				3									
3/2 U - Universal																					
G1/8	2.3	0.2	0.23		0	4	4								23	14		L323V01G	ZA10A	FKM	1,2,3
Barbed ports						4	4	4				23			14		12		ZA10G		
				Barbed ports with ring nut		0.12	0.14	4	4	4	4	23	14	12	L323V02G	ZA10A	2,3				
4								4	4	4	23	14	12	L323V03G	ZA10G						
Barbed ports				0.2		0.23	4	4	4	4	23	14		12	L323V04G	ZA10A	2,3				
							4	4	4	4	23	14	12	L323V04G	ZA10G						

* Sealings: FKM = Fluoro-carbon elastomer

1 Maximum driving torque of the pipe fittings for thread connections = 2Nm

2 Only for use with steam, consider following values: PSmax 2.8 bar (max fluid temperature 130°)

3 The pressure values shown in the table refer to the potential of the valve: they can be lower depending on the connection system used

4 Maximum driving torque of ring nut 1.2Nm

5 Only for use with steam, consider following values: PSmax 2.8 bar (max fluid temperature 130°)

ASCO™ MINIATURE SOLENOID VALVES

GENERAL SERVICE VALVES

SERIES
L123/L257/L323

Dimensions: mm (inches)

L123V01

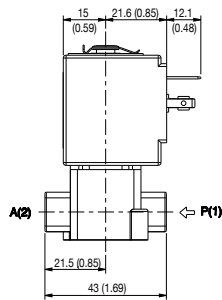
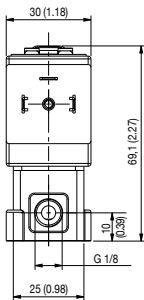
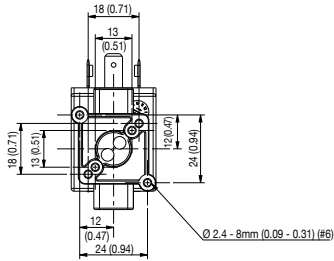

L123V02

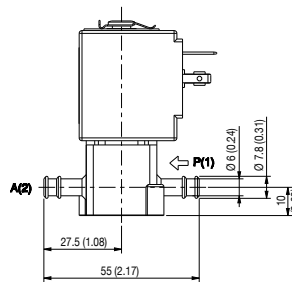

L123V03

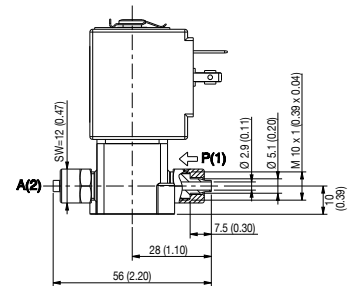

L123 V04

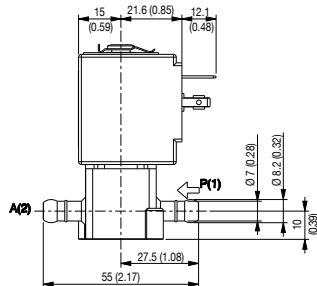
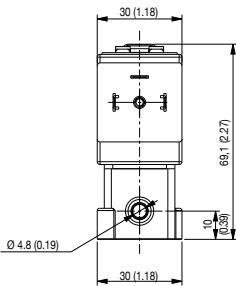
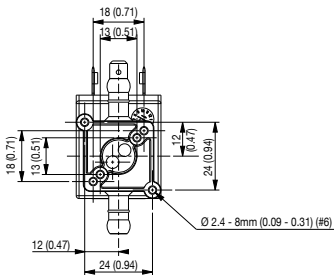

01094GB-2019-R01

Dimensions: mm (inches)

L257V02

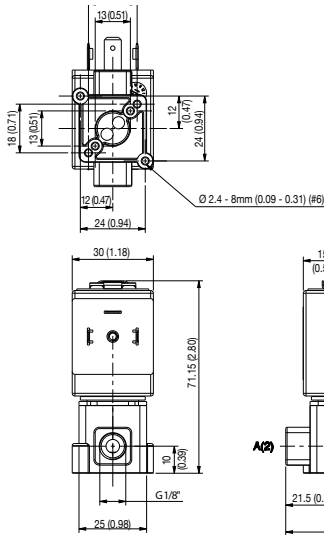

L257V01

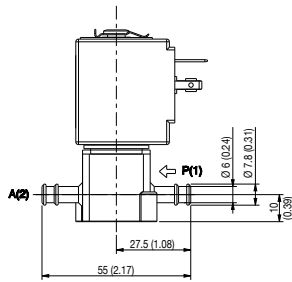
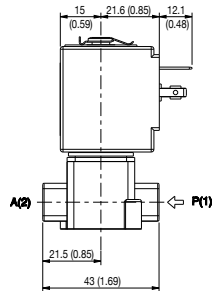

L257V03

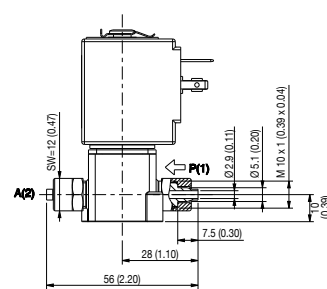

L257V04

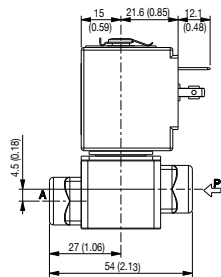
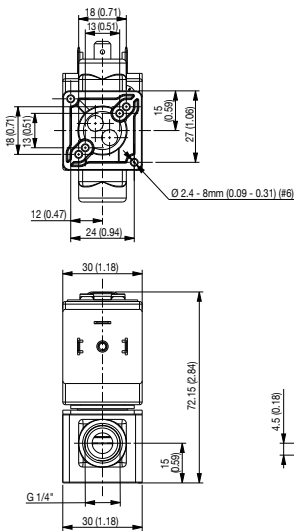

L257V05

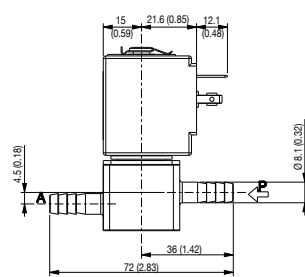
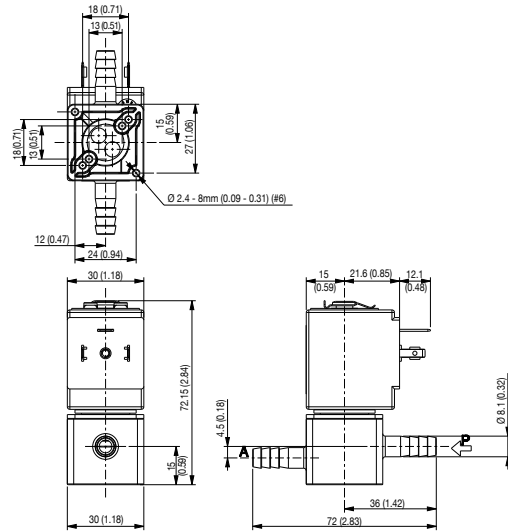

ASCO™ MINIATURE SOLENOID VALVES

GENERAL SERVICE VALVES

SERIES
L123/L257/L323

Dimensions: mm (inches)

L257V06

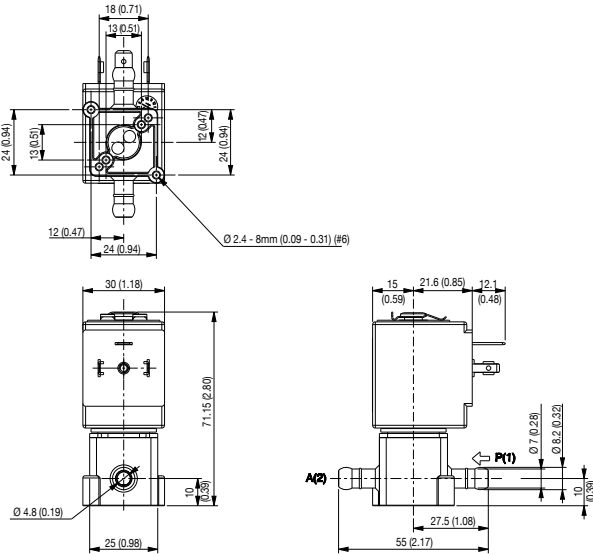

L323V01G

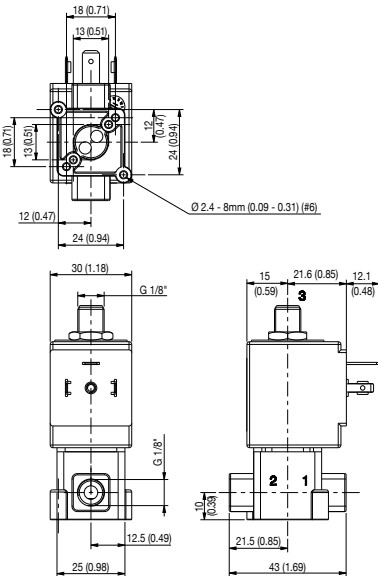

L323V02G

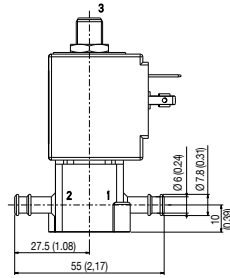

L323V03G

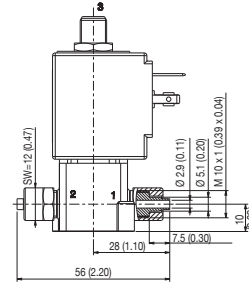

01094GB-2019-R01

Dimensions: mm (inches)

L323-V04G

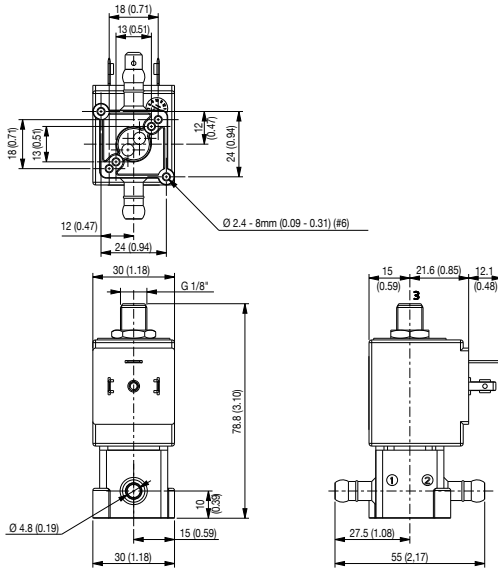

Spare Part Kits

L123-V01/V02/V03/V04

Kit description	Kit P.N.	Consisting of:
Core kit	G3139401	Core
Core return spring kit	G3022401	N.10 core return spring
O-Ring guide assembly kit	GU2428000017	N.10 O-Ring guide assembly
Guide assembly kit	G31487	Guide assembly Coil clip
Coil	ZA10A	Coil

L257-V01/V02/V03

Kit description	Kit P.N.	Consisting of:
Core kit	G3138301	Core return spring Core O-Ring guide assembly Pusher Sealing disc return spring Sealing disc
Core return spring kit	G290513-001	N°.10 Core return spring
O-Ring guide assembly kit	GU2428000015	N°.10 OR guide assembly
Guide assembly kit	G31488	Guide assembly Coil clip
Coil	ZA10A	Coil

L257-V04 / L257-V05

Kit description	Kit P.N.	Consisting of:
Core kit	G3138301	Core return spring Core O-Ring guide assembly Pusher Sealing disc return spring Sealing disc
Core return spring kit	G290513-001	N°.10 Core return spring
O-Ring guide assembly kit	GU2428000015	N°. 10 OR guide assembly
Guide assembly kit	G31488	Guide assembly Coil clip
Coil	ZA10A ZA10B	Coil

L257-V06

Kit description	Kit P.N.	Consisting of:
Core kit	G3138301	Core return spring Core O-Ring guide assembly Pusher Sealing disc return spring Sealing disc
Core return spring kit	G290513-001	N°.10 Core return spring
O-Ring guide assembly kit	GU2428000015	N°. 10 OR guide assembly
Guide assembly kit	G31488	Guide assembly Coil clip
Coil	ZA10A	Coil

L323-V01G/V02G/V03G/V04G

Kit description	Kit P.N.	Consisting of:
Core kit	G3065101	Core
Core return spring kit	G3022401	N.10 core return spring
O-Ring guide assembly kit	GU2428000017	N.10 O-Ring guide assembly
Guide assembly	290564-001R	Guide assembly
Coil	ZA10A ZA10G	Coil

Installation

- Solenoid valve can be mounted in any position; vertical with coil upwards preferred.
- When using any sealant for fittings, please check its chemical compatibility with body material (PPS).
- In case of disassembling for usual maintenance, the fixing screws of the guide assembly have to be tightened with 0.6±0.7 Nm torque.

