

Model S-20

High Performance Pressure Transmitter for General Industrial Applications

WIKA Datasheet S-20

Applications

- General industrial applications
- Demanding research and development applications
- Harsh industrial environments

Special Features

- Measuring ranges from 0...10 to 0...20,000 psi (0 ... 0.4 to 0 ... 1,600 bar)
- Non-linearity of up to 0.125 % B.F.S.L.
- Available output signals include 4 ... 20 mA, 0 ... 10 VDC, 1 ... 5 VDC and many others
- Industry standard electrical connections including DIN 175301-803A L- connector, cables, housings and many others
- Common USA and international process connections available

Description

The model S-20 pressure transmitter is the ideal solution for customers with demanding performance requirements in many industrial applications.

It features high accuracy, a robust design and is available with an exceptional number of options that make it suitable for an extremely broad range of pressure measurement applications.

High versatility

The model S-20 offers continuous measuring ranges between 0...10 psi and 0...20,000 psi (0 ... 0.4 and 0 ... 1,600 bar) in all common engineering units. Vacuum and compound ranges are also available.

These measuring ranges can be combined with virtually any standard industry output signal, common international process connections and a wide variety of electrical connections. A large number of options are available including different accuracy classes, extended temperature ranges and customer specific pin assignments to provide compatibility with most industrial applications.

Data sheets showing similar products:
Pressure transmitter for general industrial applications; model A-10; see data sheet PE 81.60



Model S-20 Pressure Transmitter

High quality

The rugged design makes the model S-20 a highly reliable transmitter that is not affected by most adverse environmental conditions. This transmitter meets most application performance requirements when exposed to very low outdoor temperatures, extreme shock and vibration and aggressive media.

Availability

Variations of the S-20 described in this data sheet are usually available with short lead times. Inventory of popular designs are usually available for particularly urgent requirements.

Measuring ranges

Relative pressure ranges							
psi	0 ... 10	0 ... 15	0 ... 25	0 ... 30	0 ... 50	0 ... 60	0 ... 100
	0 ... 150	0 ... 160	0 ... 200	0 ... 250	0 ... 300	0 ... 400	0 ... 500
	0 ... 600	0 ... 750	0 ... 1,000	0 ... 1,500	0 ... 2,000	0 ... 3,000	0 ... 4,000
	0 ... 5,000	0 ... 6,000	0 ... 7,500	0 ... 10,000	0 ... 15,000	0 ... 20,000	
bar	0 ... 0.4	0 ... 0.6	0 ... 1	0 ... 1.6	0 ... 2.5	0 ... 4	0 ... 6
	0 ... 10	0 ... 16	0 ... 25	0 ... 40	0 ... 60	0 ... 100	0 ... 160
	0 ... 250	0 ... 400	0 ... 600	0 ... 1,000	0 ... 1,600		

Absolute pressure ranges							
psi	0 ... 10	0 ... 15	0 ... 25	0 ... 30	0 ... 50	0 ... 60	0 ... 100
	0 ... 150	0 ... 160	0 ... 200	0 ... 250	0 ... 300	0 ... 400	0 ... 500
bar	0 ... 0.4	0 ... 0.6	0 ... 1	0 ... 1.6	0 ... 2.5	0 ... 4	0 ... 6
	0 ... 10	0 ... 16	0 ... 25	0 ... 40			

Vacuum and compound ranges					
psi	-30 inHg ... 0	-30 inHg ... +15	-30 inHg ... +30	-30 inHg ... +45	-30 inHg ... +60
	-30 inHg ... +100	-30 inHg ... +160	-30 inHg ... +200	-30 inHg ... +300	-30 inHg ... +500
bar	-0.4 ... 0	-0.6 ... 0	-1 ... 0	-1 ... +0.6	-1 ... +1.5
	-1 ... +3	-1 ... +5	-1 ... +9	-1 ... +15	-1 ... +24
	-1 ... +39	-1 ... +59			

The listed pressure ranges are also available in kg/cm², kPa and MPa.

Special measuring ranges between 0 ... 10 and 0 ... 20,000 psi (0.4...1600 bar) are available on request.

Special pressure ranges may have reduced long-term stability and increased temperature errors.

Overpressure limit

The overpressure limit depends on the specific sensor element used for the selected pressure range. A reduction in the overpressure safety rating may occur depending on the specific process connection and seal selected. A higher overpressure limit may provide a greater temperature error.

Measuring range < 150 psi/10 bar	≥ 150 psi/10 bar
3 times (standard)	2 times ¹⁾ (standard)
5 times	3 times ^{2) 3)}

1) Restriction: max. 60 bar/870 psi with absolute pressure

2) Only possible for relative pressure measuring ranges ≤ 400 bar or 5,800 psi

3) Only possible for absolute pressure measuring ranges < 16 bar or 220 psi

Vacuum resistance

Yes

(No damage to sensor when vacuum is applied)

Output signal

Signal type	Signal
Current (2-wire)	4 ... 20 mA 20 ... 4 mA
Voltage (3-wire)	DC 0 ... 10 V DC 0 ... 5 V DC 1 ... 5 V DC 0.5 ... 4.5 V DC 1 ... 6 V DC 10 ... 0 V
Ratiometric (3-wire)	DC 0.5 ... 4.5 V

Other output signals on request.

Permissible load in Ω

- Current output (2-wire): $\leq (\text{power supply} - 7.5 \text{ V}) / 0.023 \text{ A}$
 $\leq (\text{power supply} - 11.5 \text{ V}) / 0.023 \text{ A}$ (with optional settling time of 1 ms)
- Voltage output (3-wire): $> \text{maximum output voltage} / 1 \text{ mA}$
- Ratiometric output (3-wire): $> 4.5\text{k}$

Optional output signal limits

- 4 ... 20 mA signal: Minimum zero point setting: 3.6 mA ¹⁾, 3.8 mA, 4.0 mA
Maximum full scale setting: 20 mA, 21.5 mA, 23 mA
- DC 0 ... 10 V signal: Full scale: 10 VDC or 11.5 VDC

¹⁾ Not available with the zero point adjustment option

Voltage supply

Power supply

Maximum allowable power supply rating for cULus approval: 35 VDC (32 VDC with heavy-duty connector)

- Current output (2-wire)
 - 4 ... 20 mA: 8 ... 36 VDC (12 ... 36 VDC with optional 1 ms settling time)
 - 20 ... 4 mA (reverse output): 8 ... 36 VDC
- Voltage output (3-wire)
 - 0 ... 10 VDC: 12 ... 36 VDC
 - 0 ... 5 VDC: 8 ... 36 VDC
 - 1 ... 5 VDC: 8 ... 36 VDC
 - 0.5 ... 4.5 VDC: 8 ... 36 VDC
 - 1 ... 6 VDC: 9 ... 36 VDC
 - 10 ... 0 VDC: 12 ... 36 VDC
- 3-wire ratiometric output:
 - 0.5 ... 4.5 VDC: 5 VDC $\pm 10\%$

Power dissipation (loss)

- Current output (2-wire): 828 mW (22 mW/K derating of the power dissipation when ambient temperatures are $\geq 212^\circ \text{F} / 100^\circ \text{C}$)
- Voltage output (3-wire): 432 mW

Maximum current consumption

- Current output (2-wire): Current signal, max. 25 mA
- Voltage output (3-wire): max. 12 mA

Reference conditions (per IEC 61298-1)

Temperature

59...77°F (15...25°C)

Barometric pressure

860 ... 1,060 mbar

Humidity

45 ... 75 % relative

Power supply

- 24 VDC
- 5 VDC for ratiometric output

Mounting position

Calibrated in vertical position with pressure connection facing down

Response time

Signal type	Settling time per IEC 62594		Signal damping
	Standard ¹⁾	Option 1 ^{2) 3)}	Option 2
Current (2-wire)	3 ms	1 ms	10, 50, 100, 500, 1,000, 5,000 ms
Voltage (3-wire)	2 ms	1 ms	10, 50, 100, 500, 1,000, 5,000 ms
Ratiometric (3-wire)	2 ms	1 ms	10, 50, 100, 500, 1,000, 5,000 ms

1) 3 dB limit frequency: 500 Hz

2) 3 dB limit frequency: 1,000 Hz

3) Alternative specifications for 4 ... 20 mA output signal:

Load: $\leq (\text{power supply} - 11.5 \text{ V}) / 0.023 \text{ A}$

Power supply: DC 12 ... 36 V

Switch-on time (from power up to output signal)

150 ms

Switch-on drift time

5 s to reach stated accuracy (60 s with optional 0.1 % zero point adjustment)

Accuracy data

Non-linearity (per IEC 61298-2)		Accuracy at calibration temperature
BFSL	Terminal method	
≤ ±0.5 % of span (standard)	≤ ±1.0 % of span	≤ ±1.0 % of span
≤ ±0.25 % of span	≤ ±0.5 % of span	≤ ±0.5 % of span
≤ ±0.125 % of span ¹⁾	≤ ±0.25 % of span ¹⁾	≤ ±0.25 % of span ¹⁾

1) Restrictions for the non-linearity of 0.125 % BFSL or 0.25 % with terminal method:
 Available output signals: 4 ...20 mA and DC 0 ... 10 V
 Available measuring ranges: All measuring ranges specified in the data sheet
 For further output signals or measuring ranges, please ask the manufacturer

Calibration temperature
15 ... 25 °C (standard)
4 °C ±5 °C
40 °C ±5 °C
60 °C ±5 °C
80 °C ±5 °C

Zero point adjustment
≤ ±0.2 % of span, factory setting (standard)
≤ ±0.1 % of span, factory setting ¹⁾
±10 % of span, in 0.05 % increments, customer setting ²⁾

1) Restrictions for the optional factory set 0.1 % zero point adjustment:
 Only available with 4 ...20 mA and 0 ... 10 VDC output signals
 Available measurement ranges: All relative pressure ranges specified in the data sheet. Not available in combination with the optional calibration temperature.
 2) The "optional zero point adjustment access" is not available with every electrical connection, see "Electrical connections" for details.

Effect of mounting position on zero offset

For measuring ranges < 15 psi (1 bar), an additional zero offset of up to 0.15 % applies

Non-repeatability

≤ ±0.1 % of span

Temperature hysteresis

0.1 % of span at > 176 °F (80 °C)

Long-term drift (per IEC 61298-2)

- ≤ ±0.1 % of span
- ≤ ±0.2 % of span (with special measuring ranges)

Temperature error (for calibration temperature of 59...77 °F (15 ... 25 °C))

For measuring ranges < 15 psi (1 bar), special measuring ranges and instruments with an increased overpressure limit the temperature error increases by 0.5 % of span

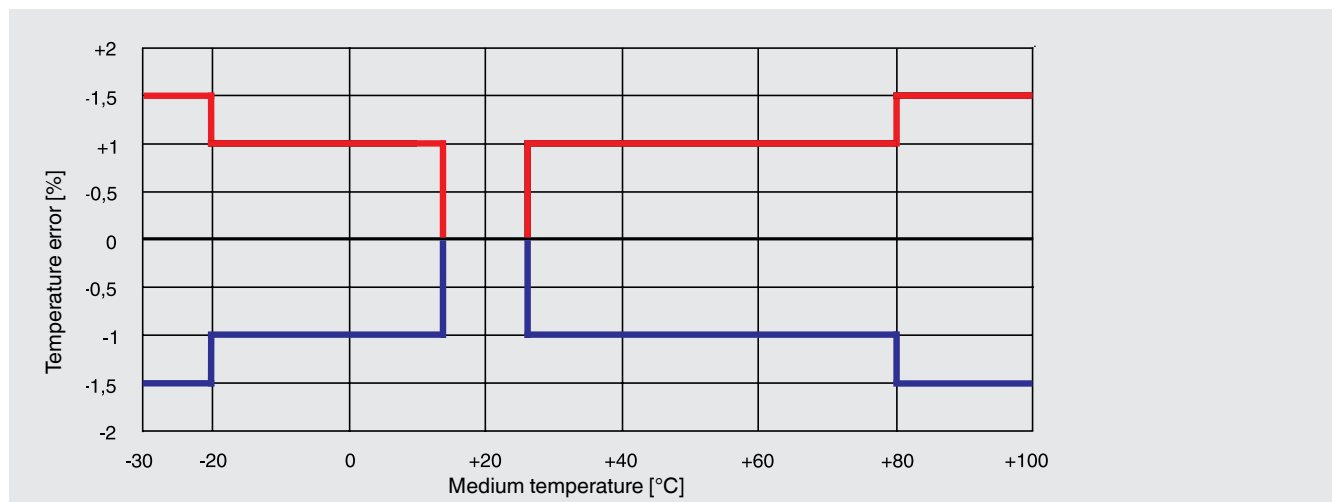

Operating conditions

Permissible temperature ranges

Medium	Ambient	Design	maximum permissible pressure
-30 ... +100 °C (standard)	-30 ... +100 °C	-	-
-40 ... +125 °C	-40 ... +125 °C	-	-
-40 ... +150 °C	-40 ... +125 °C ¹⁾	with integrated cooling element	5800 psi (400 bar)
-40 ... +200 °C	-40 ... +125 °C ¹⁾	with integrated cooling element	5800 psi (400 bar)
-20 ... +60 °C	-20 ... +60 °C	Oxygen applications	-

1) Derating curve and formula (see following diagram)

There may be other media and ambient temperature limitations depending upon the sealing material used with the process connection and the specific electrical connection selected.

For restrictions see "Process connections, sealings" and "Electrical connections".

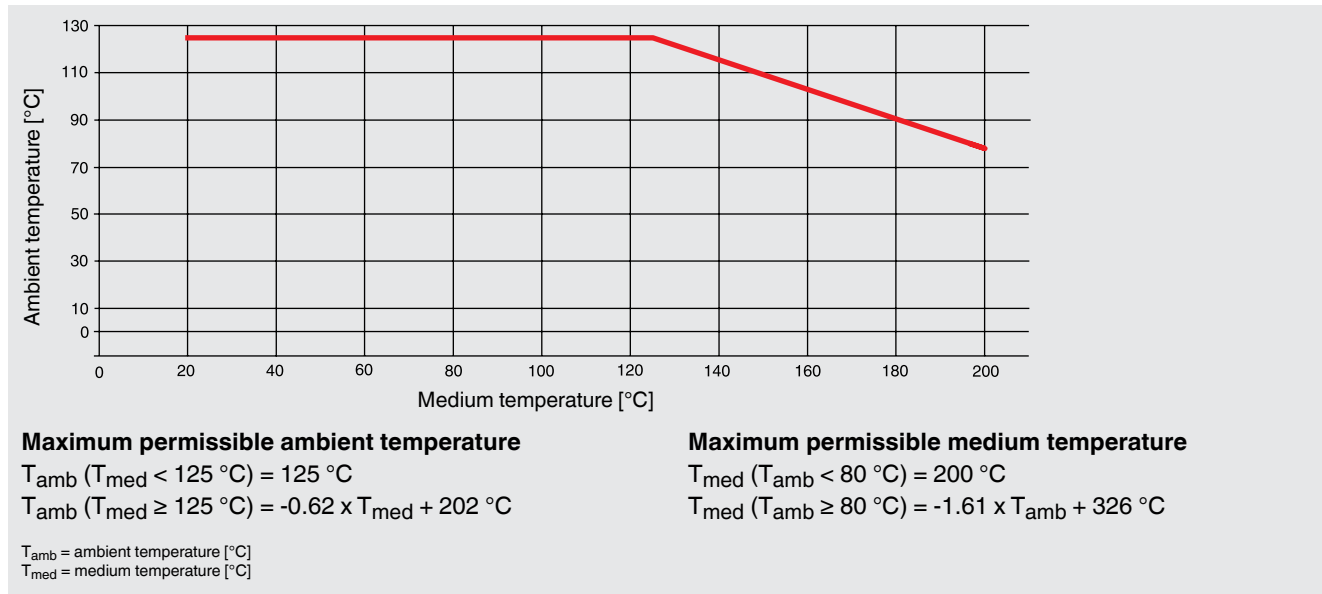

Storage and transport conditions

- Permissible temperature range: -40...158° F (-40 ... +70 °C)
- Maximum humidity (per IEC 68-2-78): 67 % r.h. at 104 F (40 °C) (in accordance with 4K4H per EN 60721-3-4)

Vibration resistance (per IEC 68-2-6)

20 g, 10 ... 2,000 Hz, (40 g, 10 ... 2,000 Hz for heavy-duty connector)
 For instruments with cooling elements a limited vibration resistance of 10 g applies (10 ... 2,000 Hz)

Continuous vibration resistance (per IEC 68-2-6)

10 g

Shock resistance (per IEC 68-2-27)

100 g, 6 ms (500 g, 1 ms for heavy-duty connector)

Service life

100 million load cycles (10 million load cycles for measuring ranges > 7,500 psi /600 bar)

Free-fall test (following IEC 60721-3-2)

- Individual packaging: 5 ft (1.5 m)
- Multiple packaging: 1.6 ft (0.5 m)
- PE bag: 1.6 ft (0.5 m)

Process connections

Available connections

Process connection per	Thread size	Maximum overpressure limit
EN 837	G 1/8 B	11,600 psi (800 bar)
	G 1/4 B	20,300 psi (1,400 bar)
	G 1/4 B female	20,300 psi (1,400 bar)
	G 1/2 B	26,100 psi (1,800 bar) (1.4404) 46,400 psi (3,200 bar) (1.4542)
	G 3/8 B	20,300 psi (1,400 bar)
DIN 3852-E	G 1/4 A	8700 psi (600 bar)
	G 1/2 A	8700 psi (600 bar)
	M14 x 1.5	8700 psi (600 bar)
ISO 228	M20 x 1.5	26,100 psi (1,800 bar) (1.4404) 47,800 psi (3,300 bar) (1.4542)
	M12 x 1.5	8700 psi (600 bar)
SAE J514 E	7/16-20 UNF BOSS	8700 psi (600 bar)
	7/16-20 UNF J514 sealing cone 74°	15,900 psi (1,100 bar)
	9/16-18 UNF BOSS	8700 psi (600 bar)
ANSI/ASME B1.20.1	1/8 NPT	15,900 psi (1,100 bar)
	1/4 NPT	21,700 psi (1,500 bar)
	1/4 NPT female	21,700 psi (1,500 bar)
	1/2 NPT	21,700 psi (1,500 bar) (1.4404) 40,600 psi (2,800 bar) (1.4542)
KS	PT 1/4	23,200 psi (1,600 bar)
	PT 1/2	21,700 psi (1,500 bar)
	PT 3/8	20,300 psi (1,400 bar)
ISO 7	R 1/4	23,200 psi (1,600 bar)
	R 3/8	21,700 psi (1,500 bar)
	R 1/2	20,300 psi (1,400 bar) (1.4404) 41,200 psi (2,840 bar) (1.4542)

Other process connections available on request.

Pressure port diameter

Pressure port diameter	Available for thread sizes
2.5 mm (standard)	all thread sizes
0.3 mm	G 1/4 A, G 1/2 A, 1/4 NPT, 1/2 NPT, R 1/4, 7/16-20 UNF BOSS
0.6 mm	G 1/4 A, G 1/2 A, 1/4 NPT, 1/2 NPT, R 1/4, 7/16-20 UNF BOSS
6 mm*	G 1/4 A, 1/4 NPT, R 1/4, 7/16-20 UNF BOSS
12 mm*	G 1/2 A, 1/2 NPT

*6 or 12 mm enlarged pressure port is only available for measuring ranges up to and including 0 ... 500 psi (0 ... 40 bar).

Sealing rings

Process connection per	Copper	Stainless steel	NBR	FKM
	-40 ... +125 °C	-40 ... +125 °C	-20 ... +100 °C	-15 ... +125 °C
EN 837	Standard	Option	-	-
DIN 3852-E	-	-	Standard	Option
ISO 228	Standard	Option	-	-
SAE J514 E	-	-	Standard	Option

Electrical connections

Available connections

Electrical connection	Ingress protection	Wire cross-section	Cable Ø	Cable material	maximum permissible temperature
L-connector DIN 175301-803 A ¹⁾	IP 65	-	-	-	-30 ... +100 °C
L-connector DIN 175301-803 C ¹⁾	IP 65	-	-	-	-30 ... +100 °C
Circular connector M12 x 1 (4-pin) ¹⁾	IP 67	-	-	-	-30 ... +100 °C
Circular connector M12 x 1 (4-pin, metallic)	IP 67	-	-	-	-40 ... +125 °C (cULus: +85 °C)
Bayonet connector (6-pin)	IP 67	-	-	-	-40 ... +125 °C
Field case	IP 6K9K	-	-	-	-25 ... +100 °C
Heavy-duty connector ²⁾	IP 68	-	-	-	-40 ... +125 °C
Cable outlet IP 67 ¹⁾	IP 67	3 x 0.34 mm ²	5.5 mm	PUR	-30 ... +100 °C
Cable outlet ½ NPT conduit	IP 67	6 x 0.35 mm ²	6.1 mm	PUR	-30 ... +100 °C (cULus: +90 °C)
Cable outlet IP 68	IP 68	6 x 0.35 mm ²	6.1 mm	PUR	-30 ... +125 °C (cULus: +90 °C)
Cable outlet IP 68, FEP	IP 68	6 x 0.39 mm ²	5.8 mm	FEP	-40 ... +125 °C (cULus: +105 °C)
Cable outlet IP 6K9K	IP 6K9K	6 x 0.35 mm ²	6.1 mm	PUR	-30 ... +125 °C (cULus: +90 °C)

1) Customer zero point adjustment available as an option.

2) max. DC 32 V with cULus approval

Other connections on request.

Assembly configurations of the mating connectors

Mating connector for electrical connection	Ingress protection	Wire cross-section	Cable Ø	Cable material	max. permissible temperature	Cable ends
L-connector DIN 175301-803 A						
■ Mating connector	IP 65	max. 1.5 mm ²	6 ... 8 mm	-	-40 ... +125 °C	-
■ Mating connector (conduit)	IP 65	max. 1.5 mm ²	-	-	-40 ... +125 °C	-
■ Mating connector with molded cable	IP 65	3 x 0.75 mm ²	6 mm	PUR	-40 ... +125 °C (cULus: -25 ... +85°C)	no finishing
■ Mating connector with molded cable, shielded	IP 65	6 x 0.5 mm ²	6.8 mm	PUR	-25 ... +85 °C	End splices
L-connector DIN 175301-803 C						
■ Mating connector	IP 65	max. 0.75 mm ²	4.5 ... 6 mm	-	-40 ... +125 °C	-
■ Mating connector with molded cable	IP 65	4 x 0.75 mm ²	5.9 mm	PUR	-25 ... +85 °C	no finishing
Circular connector M12 x 1 (4-pin)						
■ Mating connector, straight, with molded cable	IP 67	3 x 0.34 mm ²	4.3 mm	PUR	-25 ... +80 °C	no finishing
■ Straight mating connector, with molded cable, shielded	IP 67	3 x 0.34 mm ²	4.3 mm	PUR	-25 ... +80 °C	no finishing
■ Mating connector, angled, with molded cable	IP 67	3 x 0.34 mm ²	5.5 mm	PUR	-25 ... +80 °C	no finishing
Heavy-duty connector						
■ Mating connector with cable	IP 68	6 x 0.14 mm ²	6.5 mm	PUR	-40 ... +125 °C (cULus: -30 ... +90°C)	no finishing

Assembly configurations of the cable outlets

Electrical connection	Unfinished wire ends	Tinned wire ends	with end splices
Cable outlet IP 67	Standard	Option	Option
Cable outlet ½ NPT conduit	-	Option	Standard
Cable outlet IP 68	-	Option	Standard
Cable outlet IP 68, FEP	-	Option	Standard
Cable outlet IP 6K9K	-	Option	Standard

Cable lengths of 6 ft, 15 ft, 2 m or 5 m are available, other cable lengths on request.

Connection diagrams

L-connector DIN 175301-803 A			
		2-wire	3-wire
	U ₊	1	1
	U ₋	2	2
	S ₊	-	3
	Shield (option)	4	4

Heavy-duty connector			
		2-wire	3-wire
	U ₊	1	1
	U ₋	2	2
	S ₊	-	3
	Shield	Case	Case

L-connector DIN 175301-803 C			
		2-wire	3-wire
	U ₊	1	1
	U ₋	2	2
	S ₊	-	3
	Shield (option)	4	4

Circular connector M12 x 1 (4-pin)			
		2-wire	3-wire
	U ₊	1	1
	U ₋	3	3
	S ₊	-	4
	Shield (option)	Case	Case

Bayonet connector (6-pin)			
		2-wire	3-wire
	U ₊	A	A
	U ₋	B	B
	S ₊	-	C
	Shield	Case	Case

Field case			
		2-wire	3-wire
	U ₊	1	1
	U ₋	2	2
	S ₊	-	3
	Shield	5	5

Cable outlet incl. mating connector with molded cable			
		2-wire	3-wire
	U ₊	brown (BN)	brown (BN)
	U ₋	blue (BU)	blue (BU)
	S ₊	-	black (BK)
	Shield	grey (GY)	grey (GY)

Cable outlet (US code)			
		2-wire	3-wire
	U ₊	red (RD)	red (RD)
	U ₋	black (BK)	black (BK)
	S ₊	-	white (WH)
	Shield	grey (GY)	grey (GY)

Other pin assignments on request.

Electrical protection

The electrical protection measures below do not apply to ratiometric output signals.

- Short-circuit protection: S₊ vs. U₋
- Reverse polarity protection: U₊ vs. U₋
- Overvoltage protection: 40 VDC
- Insulation voltage: 750 VDC

Materials

Wetted parts

- Relative measuring ranges:
 - Measuring ranges ≤ 150 psi / 10 bar: 316L
 - Measuring ranges > 150 psi / 10 bar: 316L + 13-8 PH
- Absolute pressure measuring ranges:
 - Measuring ranges ≤ 10,000 psi / 1,000 bar: ASTM 630 and 13-8 PH
 - Measuring ranges > 10,000 psi / 1,000 bar: 316L + 13-8 PH
- Sealing materials: see "Process connections"

Non-wetted parts

- Case: 316 Ti
- Zero point adjustment ring: PBT/PET GF30
- Electrical connections:
 - L-connector DIN 175301-803 A: PBT/PET GF30
 - L-connector DIN 175301-803 C: PBT/PET GF30
 - Circular connector M12 x 1 (4-pin): PBT/PET GF30
 - Circular connector M12 x 1 (4-pin, metallic): 316L
 - Bayonet connector (6-pin): 316L + Al
 - Field case: 316L, 316Ti
 - Heavy-duty connector: 316L
 - Cable outlet IP 67: PA66
 - Cable outlet ½ NPT conduit: 316L
 - Cable outlet IP 68: 316L
 - Cable outlet IP 68, FEP: 316L
 - Cable outlet IP 6K9K: 316L

Pressure transmission fluid

Synthetic oil (for measuring ranges < 150 psi / 10 bar relative and absolute pressure)

Options for specific media

Medium	Option
Food	Food-compatible transmission fluid
Oil and grease free	Residual hydrocarbon: < 1,000 mg/m ² Packaging: Protection cap on the process connection
Oxygen, oil and grease free	Residual hydrocarbon (measuring range < 30 bar): < 500 mg/m ² Residual hydrocarbon (measuring range > 30 bar): < 200 mg/m ² Packaging: Protection cap on the process connection, instrument sealed in a PE bag Maximum permissible temperature -20 ... +60 °C Elastomer sealing: oly FKM possible, max. -15 ... +60 °C and max. 30 bar measuring range. Not possible with process connections with female thread
Hydrogen	On request Measuring ranges: from 25 bar relative Wetted parts: 316L and Elgiloy® (2.4711) Maximum permissible temperature: -30 ... +30 °C

CE conformity

Pressure equipment directive

97/23/EC

EMC directive

2004/108/EC, EN 61326 emission (group 1, class B) and interference immunity (industrial application)

EM field

30 V/m (80 ... 1,000 MHz)

RoHS conformity

Directive 2002/95/EC

Performance level (per EN ISO 13849-1:2008)

- Performance level: PL = C
- Category: Cat. = 1
- Diagnostic coverage: DC = none
- MTTF: > 100 years

Certificates (optional)

Available certificates	
2.2 test report	State-of-the-art manufacturing Wetted metallic parts Confirmation of the class and indication accuracy
3.1 inspection certificate	Wetted metallic parts Wetted metallic parts with suppliers' certificate Confirmation of the class and indication accuracy List of single measured values
DKD/DAkkS calibration certificate	

Approvals and certificates, see website

Scope of delivery

Test report

- Non-linearity 0.5 % (B.F.S.L.) 3 points
- Non-linearity 0.25 % (B.F.S.L.) 5 points
- Non-linearity 0.125 % (B.F.S.L.) 5 points

Packaging

Individual packaging (standard)

Multiple packaging (up to 20 pieces)

Instrument labeling

WIKA laser-etched label (standard)

Customer-specific label on request

Dimensions in mm

Pressure transmitter model S-20

with L-connector DIN 175301-803 A

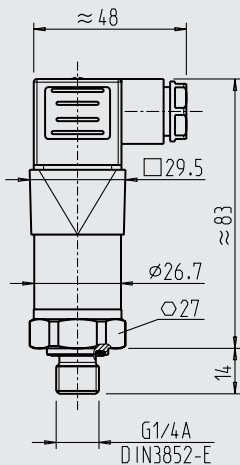

Weight: approx. 150 g

with L-connector DIN 175301-803 C

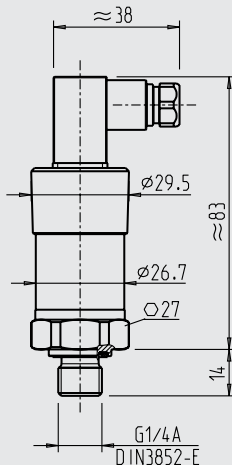

Weight: approx. 150 g

with bayonet connector (6-pin)

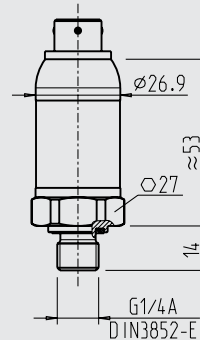

Weight: approx. 150 g

with circular connector M12 x 1 (4-pin)

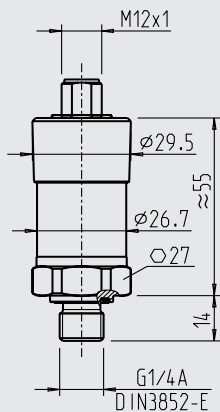

Weight: approx. 150 g

with circular connector M12 x 1 (4-pin, metallic)

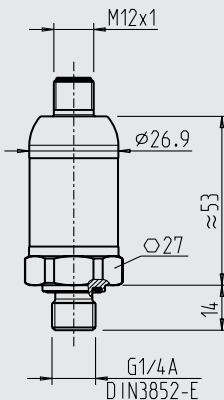

Weight: approx. 150 g

with heavy-duty connector

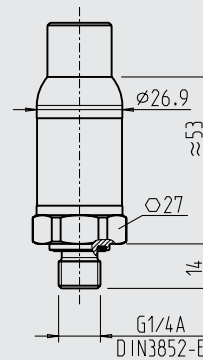

Weight: approx. 150 g

with field case

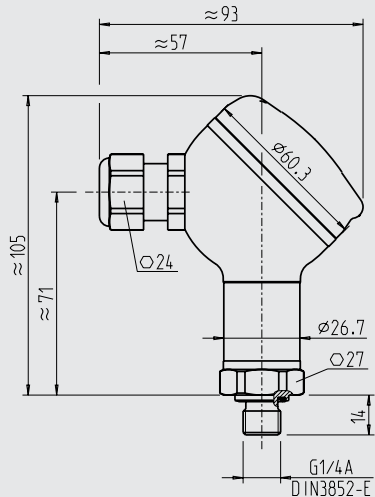

Weight: approx. 290 g

with cable outlet IP 68, FEP, IP 6K9K

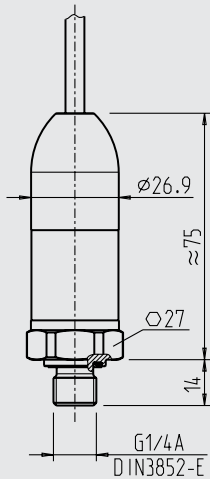

Weight: approx. 220 g

with cable outlet 1/2 NPT conduit

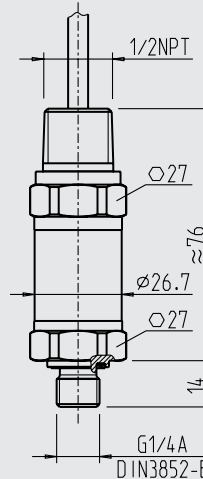

Weight: approx. 220 g

with L-connector DIN 175301-803 A and cooling element

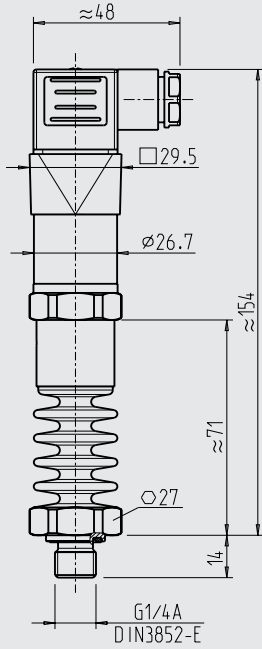

Weight: approx. 360 g

with cable outlet IP 67

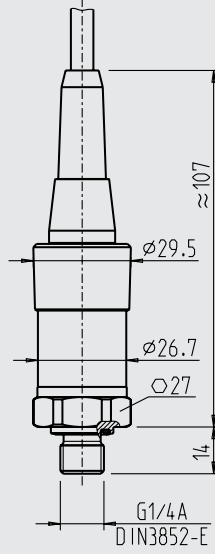

Weight: approx. 150 g

with L-connector DIN 175301-803 A and zero point adjustment

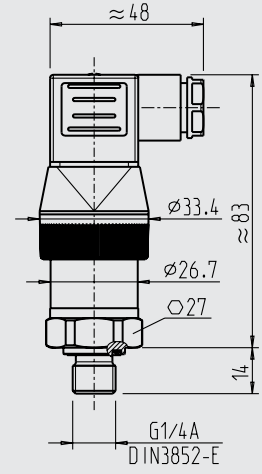

Weight: approx. 150 g

Process connections

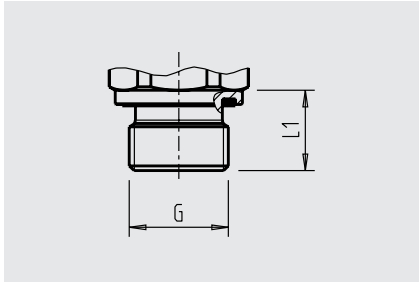

G	L1
G ¼ A	14
G ½ A	17
M14 x 1.5	14

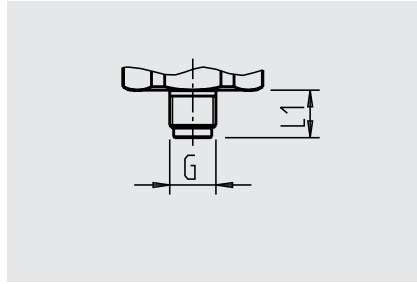

G	L1
G ⅛ B	10

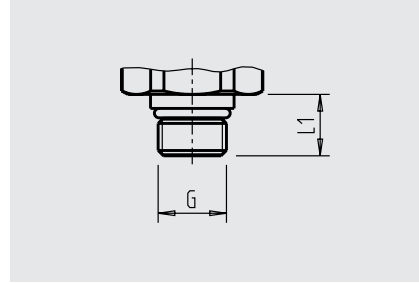

G	L1
7/16-20 UNF BOSS	12.06
9/16-18 UNF BOSS	12.85

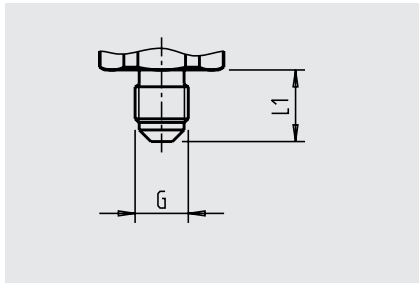

G	L1
7/16-20 UNF J514 sealing cone 74°	15

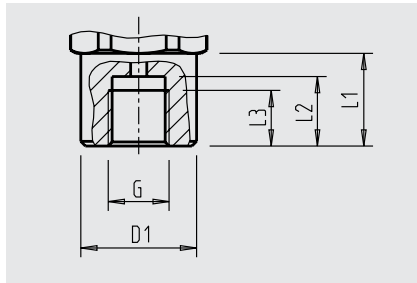

G	D1	L1	L2	L3
G ¼ B female	25	20	13	10

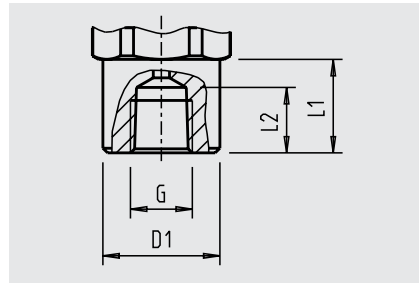

G	D1	L1	L2
¼ NPT female	25	20	14

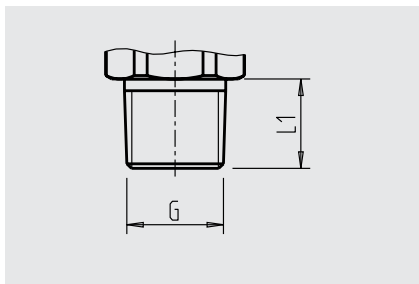

G	L1
⅛ NPT	10
¼ NPT	13
½ NPT	19
PT ¼	13
PT ½	19
PT ¾	15
R ¼	13
R ½	19
R ¾	15

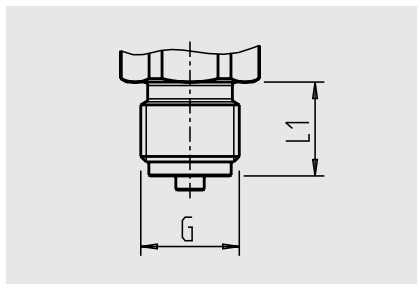

G	L1
G ¼ B	13
G ½ B	20
G ¾ B	16
M12 x 1.5	15
M20 x 1.5	20

For information on tapped holes and welding sockets, see Technical information IN 00.14 at www.wika.com.

Accessories and spare parts

Mating connector

Designation	Order number			
	without cable	with 2 m cable	with 5 m cable	with 2 m cable, shielded
L-connector DIN 175301-803 A				
■ with gland, metric	11427567	11225793	11250186	2242656
■ with gland, conduit	11022485	-	-	-
L-connector DIN 175301-803 C	1439081	11225823	11250194	-
Circular connector M12 x 1 (4-pin)				
■ straight	-	11250780	11250259	14056584
■ angled	-	11250798	11250232	-

Sealings for mating connectors

Mating connector	Order number	
	Blue (WIKA)	Brown (neutral)
L-connector DIN 175301-803 A	1576240	11437902
L-connector DIN 175301-803 C	11169479	11437881

Sealings for process connection

Thread size	Order number			
	Copper	Stainless steel	NBR	FKM
G 1/8 B	11251051	-	-	-
G 1/4 B	11250810	11250844	-	-
G 1/2 B	11250861	11251042	-	-
G 3/8 B	14065101	-	-	-
M12 x 1.5	11250810	11250844	-	-
M20 x 1.5	11250861	11251042	-	-
G 1/4 A	-	-	1537857	1576534
G 1/2 A	-	-	1039067	1039075
M14 x 1.5	-	-	1537857	1576534
7/16-20 UNF BOSS	-	-	14057554	11472022
9/16-18 UNF BOSS	-	-	14057555	2063240

Ordering information

Model / Measuring range / Overpressure limit / Output signal / Non-linearity / Calibration temperature / Zero point adjustment / Process connection / Pressure channel / Sealing / Electrical connection / Assembly / Cable length / Shielding / Certificates / Packaging / Instrument labeling / Accessories and spare parts

© 2013 WIKA Alexander Wiegand SE & Co. KG, all rights reserved.
The specifications given in this document represent the state of engineering at the time of publishing.
We reserve the right to make modifications to the specifications and materials.

