

GPR Series Precision Regulator

Inner structure

GPR300

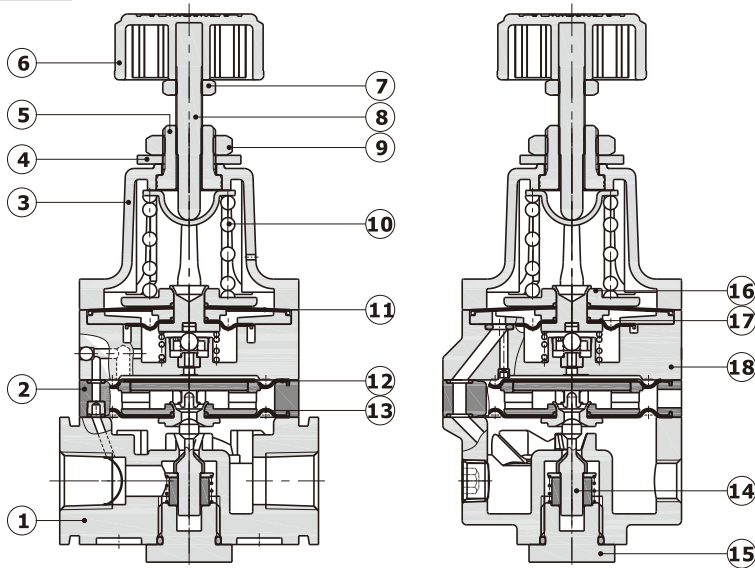

No.	Item
1	Regulator body
2	Pilot body
3	Regulator seat
4	Bracket gasket
5	Adjusting nut
6	Regulator knob
7	Nut
8	Regulator spindle
9	Nut
10	Spring
11	Pilot upper diaphragm
12	Regulator upper diaphragm
13	Regulator lower diaphragm
14	Main valve
15	Bonnet
16	Pilot diaphragm upper hard core
17	Pilot lower diaphragm
18	Nozzle body

Pressure chart

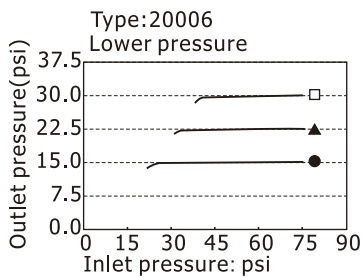

● Pressure set point:15.0psi

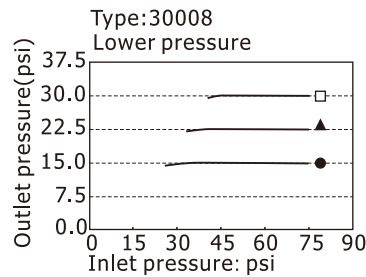

▲ Pressure set point:22.5psi

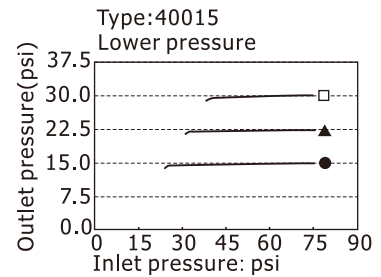

□ Pressure set point:30.0psi

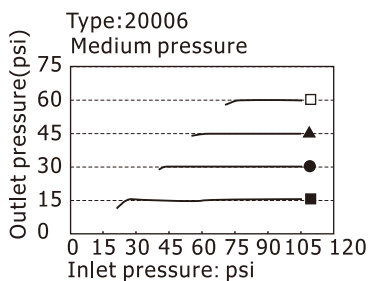

■ Pressure set point:15psi

● Pressure set point:30psi

▲ Pressure set point:45psi

□ Pressure set point:60psi

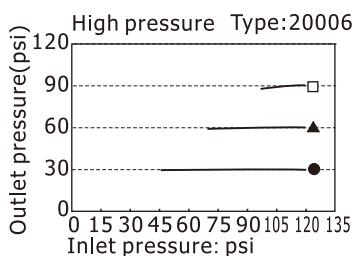
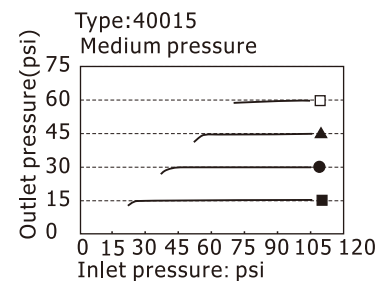
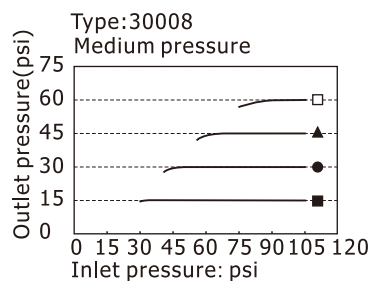

● Pressure set point:30psi

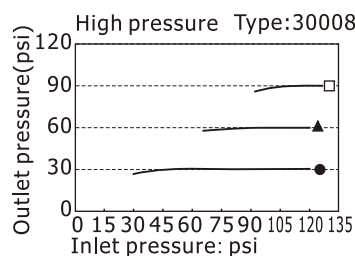

▲ Pressure set point:60psi

□ Pressure set point:90psi

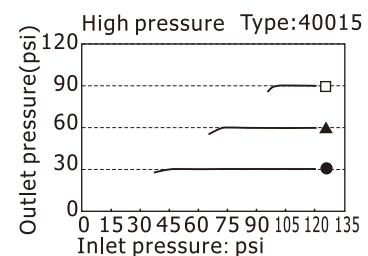

GPR Series Precision Regulator

Flow chart

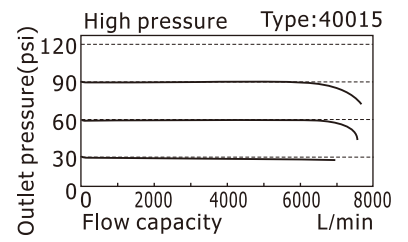
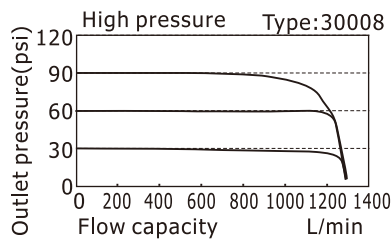
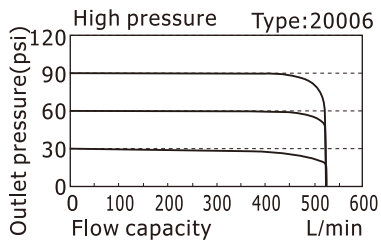
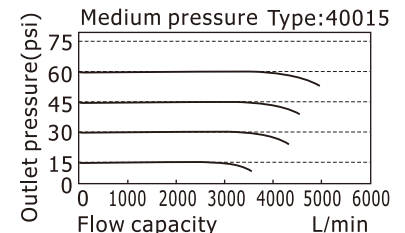
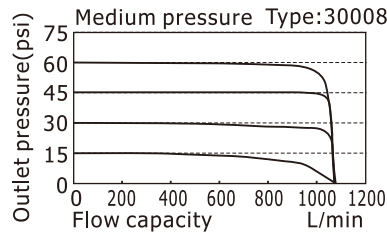
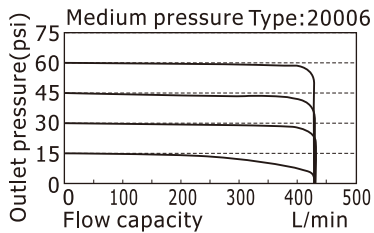
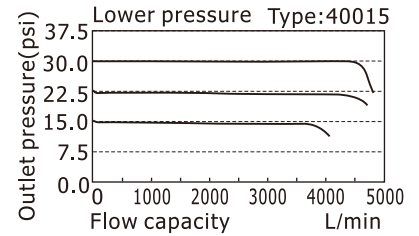
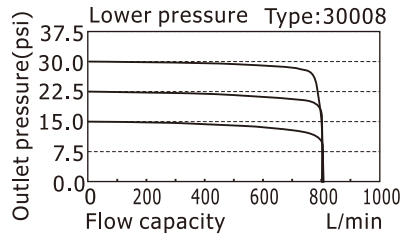
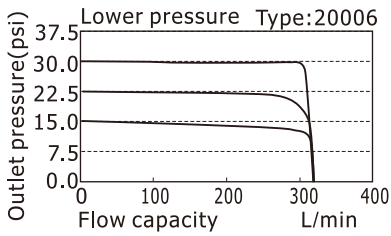

Overflow chart

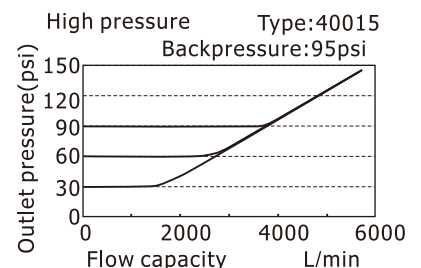
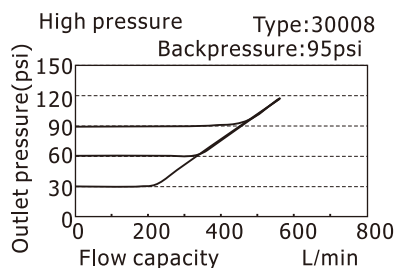
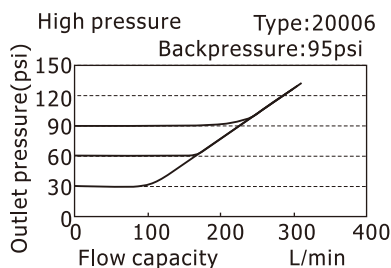
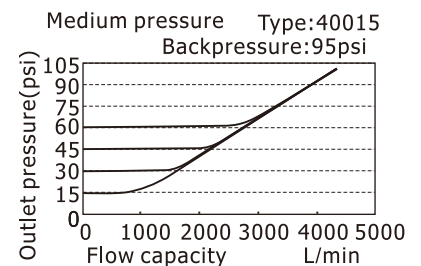
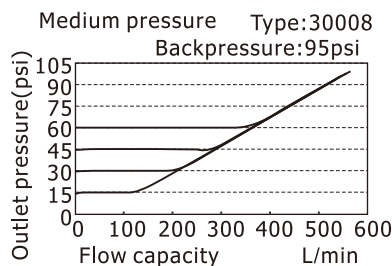
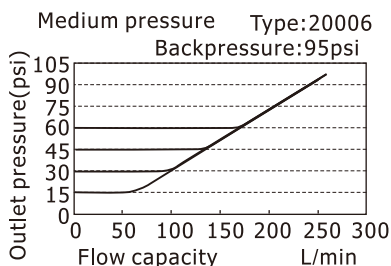
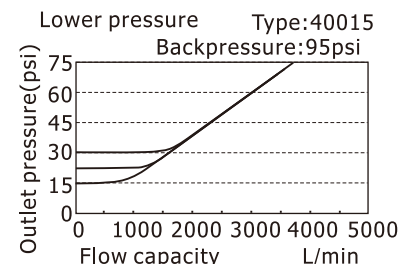
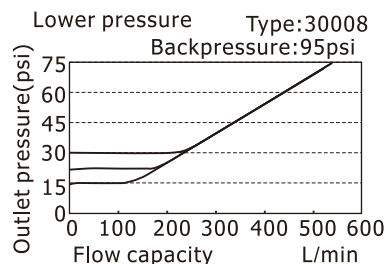
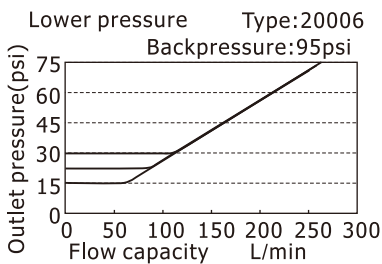

GPR Series Precision Regulator

Dimensions

GPR200

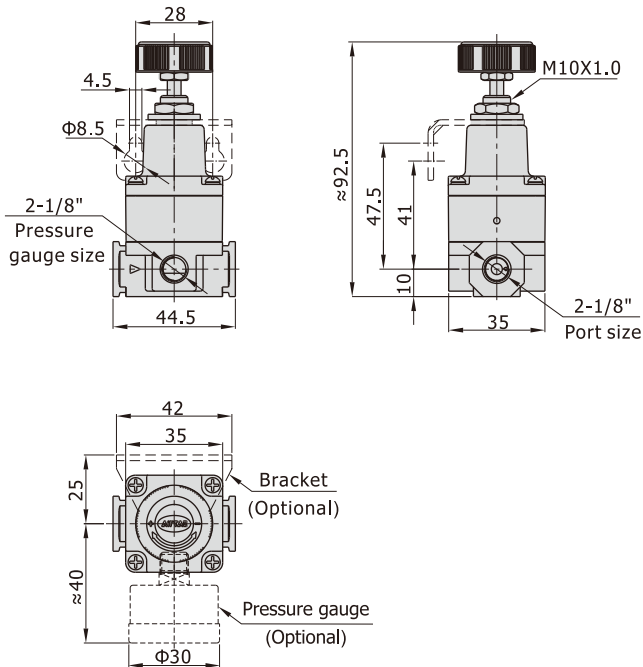

GPR300

[Unit: mm]

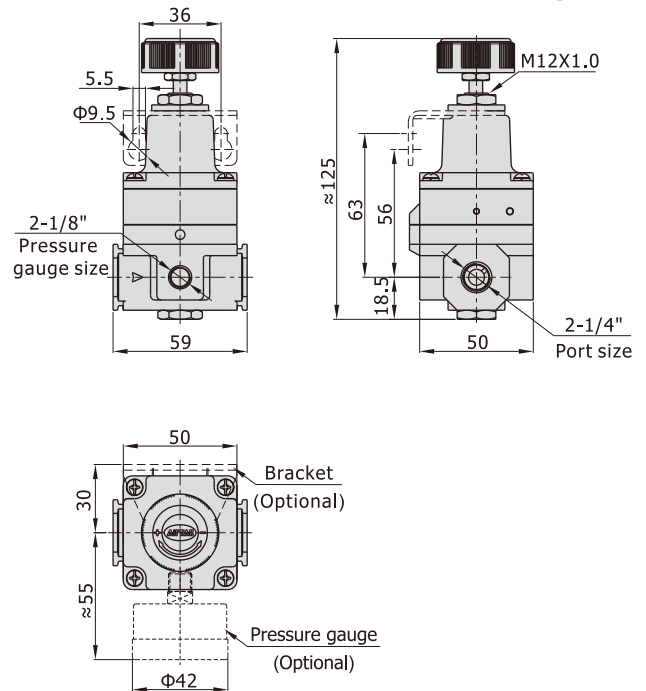

GPR400

