

## LA6

\* There is no Silver (U) body color selection for the LJ type.  
\* AC100V - 240V type is only available for LA6-5AWJWB-RYGBC.

### LA6-5DLJWB-RYGBC

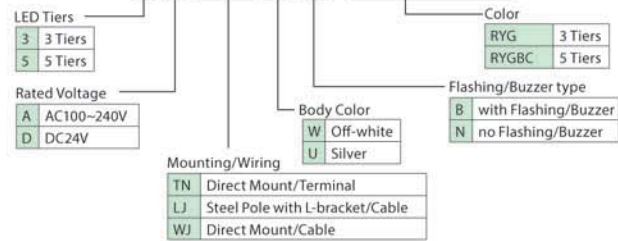

## LA6-POE

### LA6-5DTNWB-POE

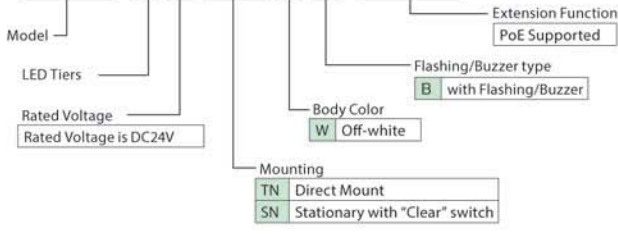

#### Specifications

Model	LA6				LA6-POE	
Rated Voltage	DC24V/AC100~240V (50Hz/60Hz)				DC24V/DC48 (PoE)	
Operating Voltage Range	DC24V±10%/AC90~250V (50Hz/60Hz)				DC24V±10%/DC36~57V (PoE)	
Rated Power Consumption	Standard	LA6-5D□□N-RYGBC	5W	LA6-5D□□B-RYGBC	6.5W	7.2W (DC24V) / 8.6W (PoE)
		LA6-3D□□N-RYG	3.5W	LA6-3D□□B-RYG	4.5W	
		LA6-5AWJWB-RYGBC	6.5W			
	Maximum	LA6-5D□□N-YYYY	7W	LA6-5D□□B-YYYY	8W	12.9W (DC26.4V) / 12.5W (PoE)
		LA6-3D□□N-YYY	4.5W	LA6-3D□□B-YYY	5.5W	
		LA6-5AWJWB-YYYY	7.5W			
Signal Line Current	Max.70mA (at DC24V)/Max.20mA (at AC100-240V)				Max. 420mA (at DC26.4V) / 10mA (for PoE)	
Operating Temperature Range	-25°C to +60°C				-10°C to +50°C	
Operating Humidity Range	Less than 90% RH, no condensation				Less than 90% RH, no freezing or condensation	
Mounting Direction	Upright/Inverted				Upright	
Protection Rating	IP65 (with Buzzer: IP54) (IEC 60529)				IP54 (Stationary type: IP20) (IEC 60529)	
Environmental Conditions	Tested while mounted in the upright position					
Mounting Location	Indoors Only					
Insulation Resistance	More than 1MΩ at DC500V between the power input lead and chassis.					
Withstand Voltage	500VAC for 1 minute between terminals and chassis without breaking insulation.					
Display Color Variations	Signal Mode: 9 colors/Smart Mode: 21 colors					
Buzzer Sounds	11 Sounds					
Sound Level	Maximum 85dB					
Environmental Conditions	Buzzer Sound No.1, in an upright position with a distance from Buzzer opening at 1meter					
Operation Method	Signal Control				Signal/Command Control	
Standard Compliances	<ul style="list-style-type: none"> <li>DC24V</li> <li>EMC Directive (EN 61000-6-4, EN 61000-6-2), RoHS Directive (EN 50581), UL508, CSA-C22.2 No. 14, FCC Part 15, Subpart B Class A, KC (KN 61000-6-4, KN 61000-6-2)</li> <li>AC100-240V</li> <li>EMC Directive (EN 61000-6-4, EN 61000-6-3), RoHS Directive (EN 50581), Low-voltage Directive (IEC/EN 60947-5-1, EN 62471)</li> </ul>				<ul style="list-style-type: none"> <li>EMC Directive (EN 61000-6-4, EN 61000-6-2, EN5032 Class A, EN 55024, RoHS Directive (EN 50581), FCC Part 15, Subpart B Class A, KC (KN 61000-6-4, KN 61000-6-2), UL 60950-1, CAN/CSA-C22.2 No. UL 60950-1-07, Recognized Component (File No. E480103).</li> <li>* The DC24V Direct Mount type conforms to the following conformities: UL508, CAN/CSA C22.2 No. 14 Recognized Component (File No. E215669)</li> </ul>	

#### Lineup

Model	Tiers	Voltage	Body Color	Type	
LA6-3DTNWB-RYG	3 Tiers	DC24V	Off-white	Direct Mount/Terminal/Buzzer	
LA6-3DTNWN-RYG				Direct Mount/Terminal/No Buzzer	
LA6-3DWJWB-RYG				Direct Mount/Cable/Buzzer	
LA6-3DWJWN-RYG				Direct Mount/Cable/No Buzzer	
LA6-3DTNWB-RYG				Silver	Direct Mount/Terminal/Buzzer
LA6-3DTNUN-RYG					Direct Mount/Terminal/No Buzzer
LA6-3DWJWB-RYG			Direct Mount/Cable/Buzzer		
LA6-3DWJUN-RYG			Direct Mount/Cable/No Buzzer		
LA6-3DLJWB-RYG			Off-white		L-Bracket with Pole/Cable/Buzzer
LA6-3DLJWN-RYG					L-Bracket with Pole/Cable/No Buzzer

Model	Tiers	Voltage	Body Color	Type		
LA6-5DTNWB-RYGBC	5 Tiers	DC24V	Off-white	Direct Mount/Cable/Buzzer		
LA6-5DTNWN-RYGBC				Direct Mount/Cable/No Buzzer		
LA6-5DWJWB-RYGBC				Direct Mount/Terminal/Buzzer		
LA6-5DWJWN-RYGBC				Direct Mount/Terminal/No Buzzer		
LA6-5DTNWB-RYGBC				Silver	Direct Mount/Terminal/Buzzer	
LA6-5DTNUN-RYGBC					Direct Mount/Terminal/No Buzzer	
LA6-5DWJWB-RYGBC			Direct Mount/Cable/Buzzer			
LA6-5DWJUN-RYGBC			Direct Mount/Cable/No Buzzer			
LA6-5DLJWB-RYGBC			Off-white		L-Bracket with Pole/Cable/Buzzer	
LA6-5DLJWN-RYGBC					L-Bracket with Pole/Cable/No Buzzer	
LA6-5AWJWB-RYGBC			AC100 - 240V	DC24V or PoE (DC48V)		Direct Mount/Cable/Buzzer
LA6-5DTNWB-POE						Direct Mount/Terminal/Ethernet/Buzzer
LA6-5DSNWB-POE	Stationary/Terminal/Ethernet/Buzzer					

**PATLITE**  
New Frontiers in Safety, Security and Comfort.

PATLITE (U.S.A.) Corporation  
20130 S. Western Ave. Torrance, CA 90501, U.S.A.  
TEL: 888-214-2580 FAX: 1-310-328-2676

PATLITE Corporation  
Osaka Midosuji Building 7F, 4-1-3, Kyutaro machi,  
Chuo-ku, Osaka City, 541-0056, JAPAN  
TEL: +81-6-7711-8956 FAX: +81-6-7711-8961

PATLITE (SINGAPORE) PTE LTD  
No.2 Leng Kee Road, #05-01 Thye Hong Centre, Singapore 159086  
TEL: +65-6226-1111 FAX: +65-6324-1411

PATLITE (CHINA) Corporation Post Code: 200072  
Room 512, Jufeng Business Building, No.697-3 Lingshi Road  
TEL: +86-21-6630-8969 FAX: +86-21-6630-8938

PATLITE Europe GmbH  
Am Soeldnermoos 8, D-85399 Hallbergmoos, Germany  
TEL: 49-811-9981-9770-0 FAX: 49-811-9981-9770-9

PATLITE KOREA CO., LTD.  
A-2603, Daesung D-POLIS, 543-1 Gasan-dong, Geumcheon-gu, Seoul, Korea  
TEL: +82-2-523-6636 FAX: +82-2-523-6637

PATLITE TAIWAN CO., LTD.  
7F, No. 91, Huayin St, Datong District Taipei, Taiwan R.O.C  
TEL: +886-2-2555-1611 FAX: +886-2-2555-1621 E-mail: info@patlite.tw

PATLITE (THAILAND) CO., LTD.  
Olympia Thai Tower, 15th Floor 444 Ratchadapisek Road Samsenok,  
Huay Kwang Bangkok 10310, Thailand  
TEL: +66-2-541-5431 FAX: +66-2-541-5429 E-mail: sales@patlite.co.th

**PATLITE**  
New Frontiers in Safety, Security and Comfort.

# LA6 SERIES

Sleek Design. Fully Customizable. Endless Possibilities.

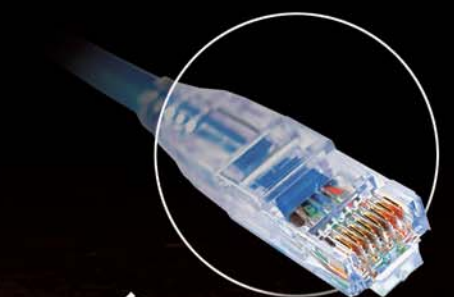

(Power over Ethernet)  
for single cable installation

# A SIGNAL TOWER DESIGNED TO SHOW MORE SO YOU CAN DO MORE



## COMMON ON-SITE OCCURRENCES

### OUR PROCESSES HAVE CHANGED.

We now need to reconfigure the color modules on our signal towers.

### OUR MACHINE LINE IS EXPERIENCING TOO MANY STOPPAGES.

We need to make our workers better aware of machine status so they can take quicker corrective measures.

### WE ARE EXPERIENCING DOWN TIME DUE TO MATERIAL MANAGEMENT.

We need earlier notifications prior to materials completely depleting to avoid delays.

### PRODUCTION STOPPAGES ARE OCCURRING AS A RESULT OF UNEVEN WORKFLOW.

Variations in work output is creating bottlenecks that can be smoothed out with a Takt system.

### WE NEED TO IMPLEMENT REMOTE MONITORING TO MINIMIZE OUR LABOR COSTS.

We need to monitor the operating status of equipment with long processing time, as well as abnormal stoppages or delays as they occur.

## LA6 SOLUTION



### Color Change

The LA6 doesn't require any hardware or wiring changes to reconfigure colors. The LA6 can be easily programmed anywhere without tools.



### Status Condition

The LA6 is able to create better, more dynamic visual signals to elicit a quicker response by workers.



### Level Meter Monitoring

The LA6 can be programmed to act as a visual level to help manage materials and material levels.



### Cycle Time

The LA6 has an internal timer function allowing you to create visual timers for a streamlined Takt system.



### Remote Monitoring

The LA6 is able to send information to other LA6 devices in remote locations via its mirroring function.

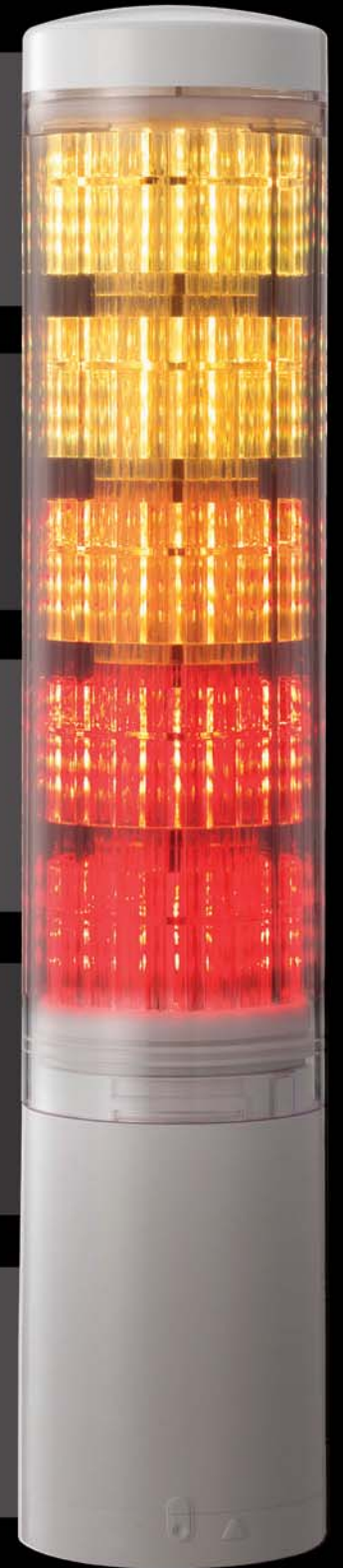

# ADVANCED OPTIONS TO SOLVE ANY APPLICATION



**Color Change**  
IMPROVE VISIBILITY WITHOUT RECONFIGURING HARDWARE



By programming the LA6 to single, all-tier colors, equipment status can now be seen at a greater distance improving awareness and response time. Reprogramming the LA6 can be performed without adjusting any of the hardware.

■ Display up to 21 different colors for different equipment statuses

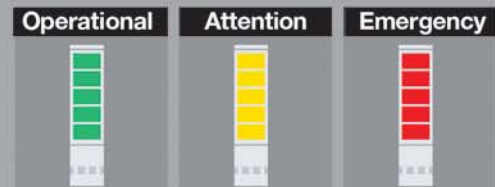

**Level Meter Monitoring**

REDUCE DOWNTIME WITH LEVEL MONITORING



By displaying current material levels, workers can more accurately respond to changes, reducing downtime. As material levels reach certain thresholds, the LA6 can provide earlier visual and audible notifications.

■ Display remaining tank levels in stages

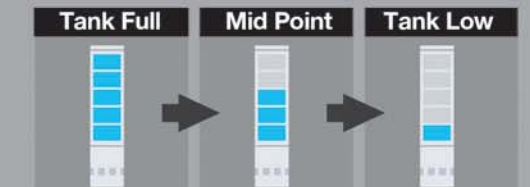

**Status Condition**  
INCREASE EFFICIENCY WITH MORE DYNAMIC VISUAL WARNINGS



The LA6 is able to display more detailed information such as the status severity level or specific abnormality conditions that workers normally would have to look for on a equipment panel or HMI.

■ Display the level of status severity



**Remote Monitoring**

WIRING MADE EASY WITH LAN CONNECTIVITY

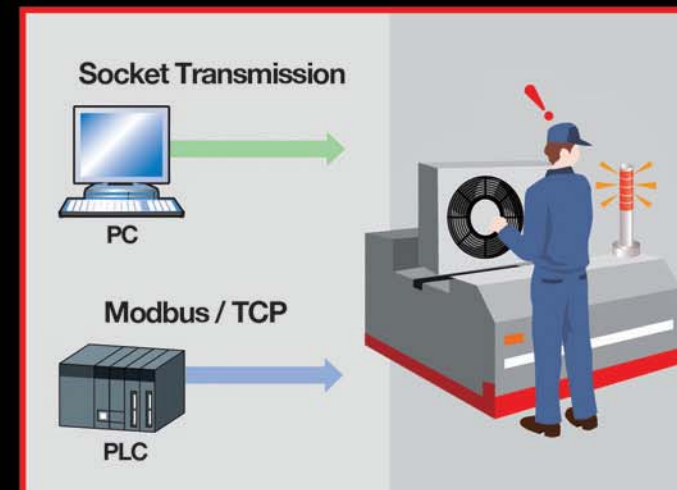

The LA6 conveniently integrates into your facilities' existing LAN infrastructure. By connecting to a PoE (Power over Ethernet) compliant HUB, the LA6 can be controlled and powered through a single cable.

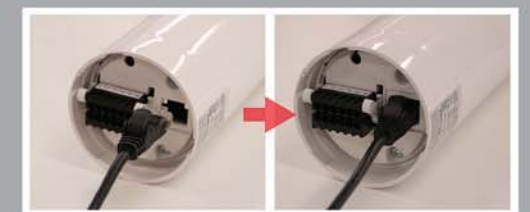

# REDUCE BOTTLENECKS WITH A VISUAL TAKT SYSTEM



## PROBLEM

Idle time or delays on the production assembly line is sometimes caused by variations in the rate of worker output.

## IMPLEMENTATION MERIT

With the LA6 visual takt system, workers will be more aware of the progress of the entire line, minimizing delays, and resulting in a smoother work flow.



## PROBLEM

Due to high volumes of products to inspect, some defective products may be overlooked and pass inspection.

## IMPLEMENTATION MERIT

With the LA6 internal timer function, inspectors are allotted proper time for each inspection resulting in an improved yield rate by accurately detecting inferior goods.

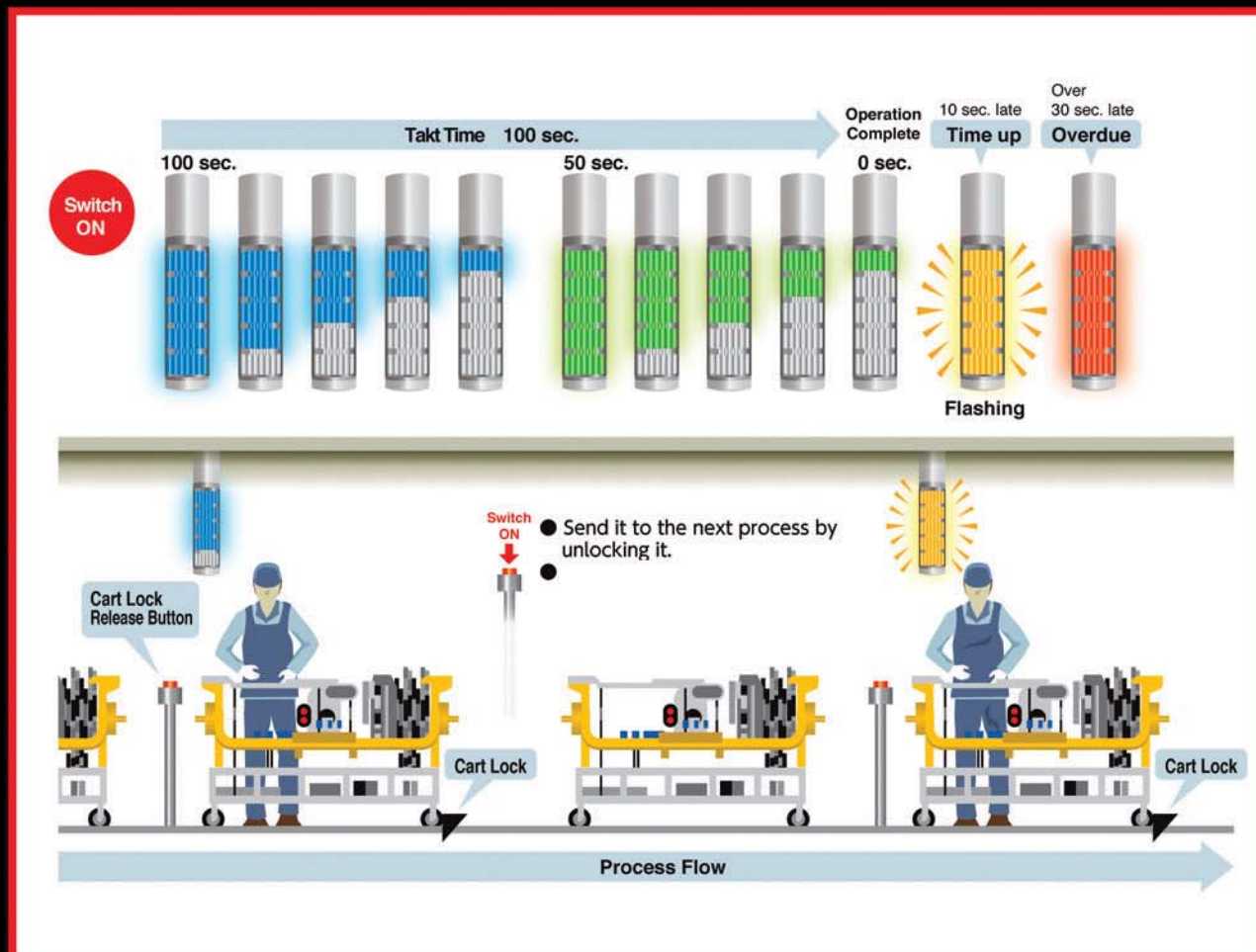

Balance the assembly line with a Takt system

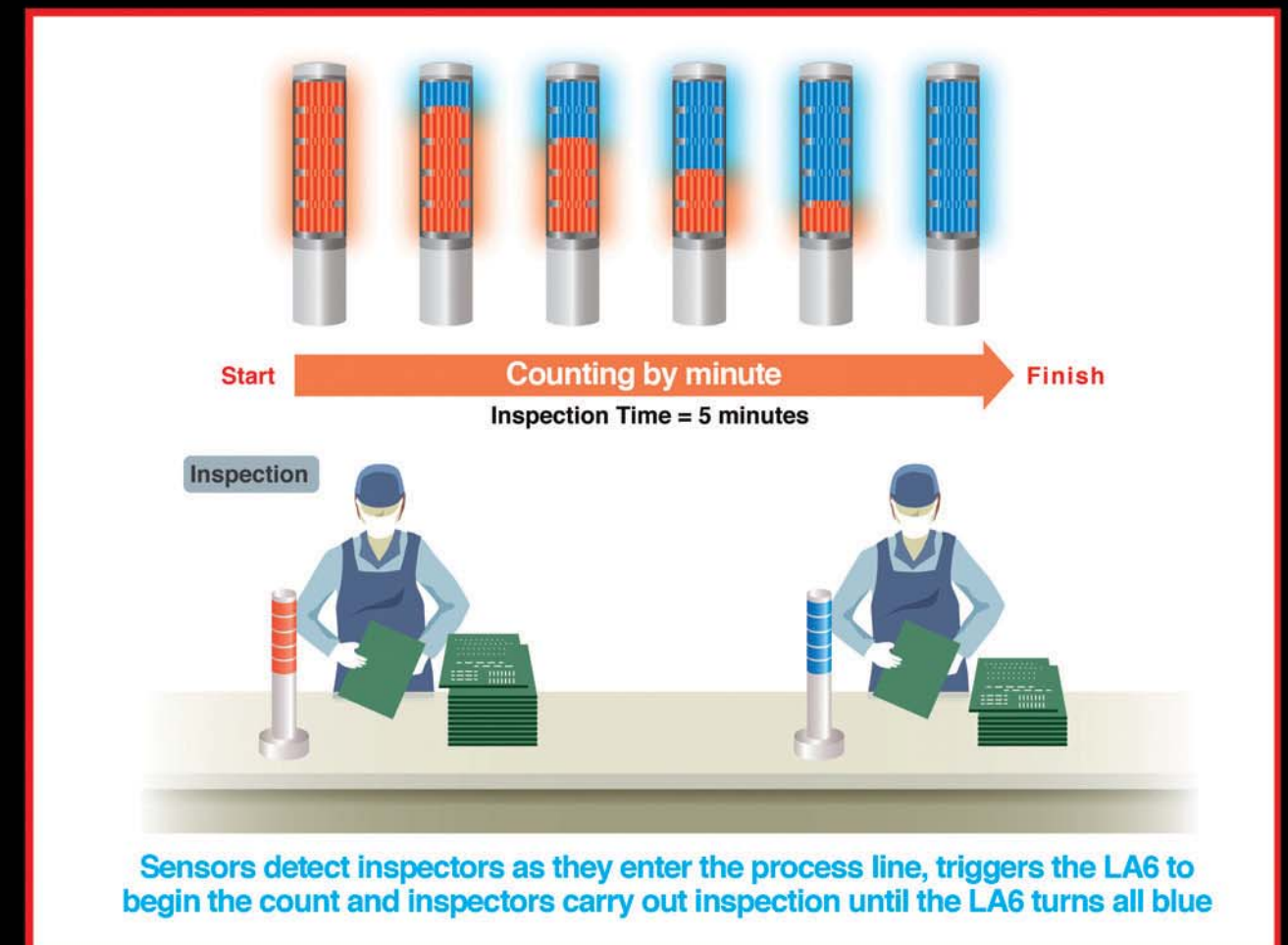

Prevent defective product outflow during inspection

# OBTAIN EQUIPMENT INFORMATION FROM REMOTE LOCATIONS



## PROBLEM

Tanks located in remote buildings tend to be overlooked until the tanks are completely depleted.

## IMPLEMENTATION MERIT

The LA6 can be used as an economical level meter system capable of alerting remote personnel of equipment changes in real-time.



## PROBLEM

Managers in remote offices need to monitor machinery status on the factory floor in real-time.

## IMPLEMENTATION MERIT

With LA6-POE's built-in mirroring function, equipment status, takt time, etc., can be communicated to other LA6 POE devices in remote locations via a LAN connection. This data can also be sent to 3rd party software through the LAN connection for data analysis or Andon monitoring.

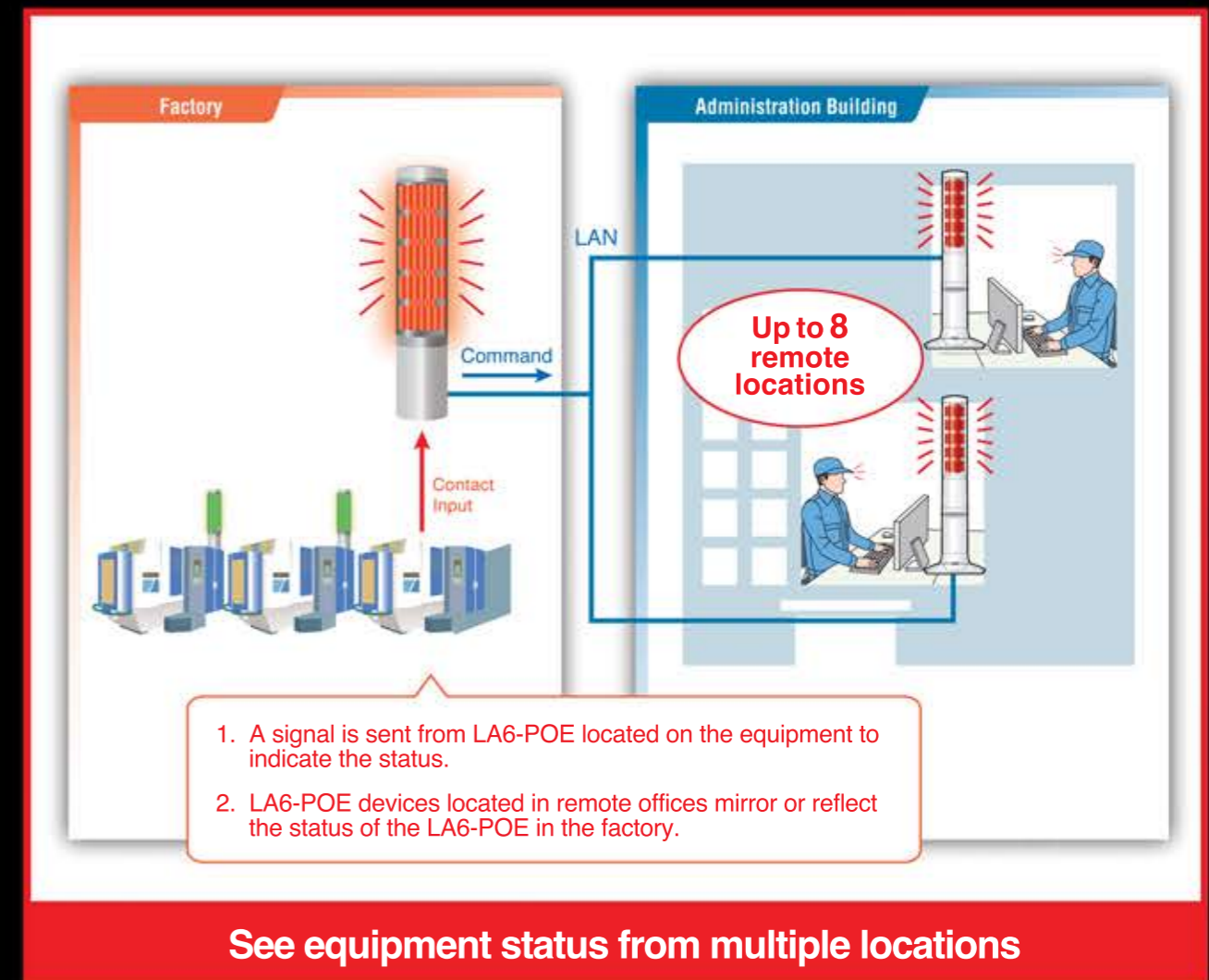
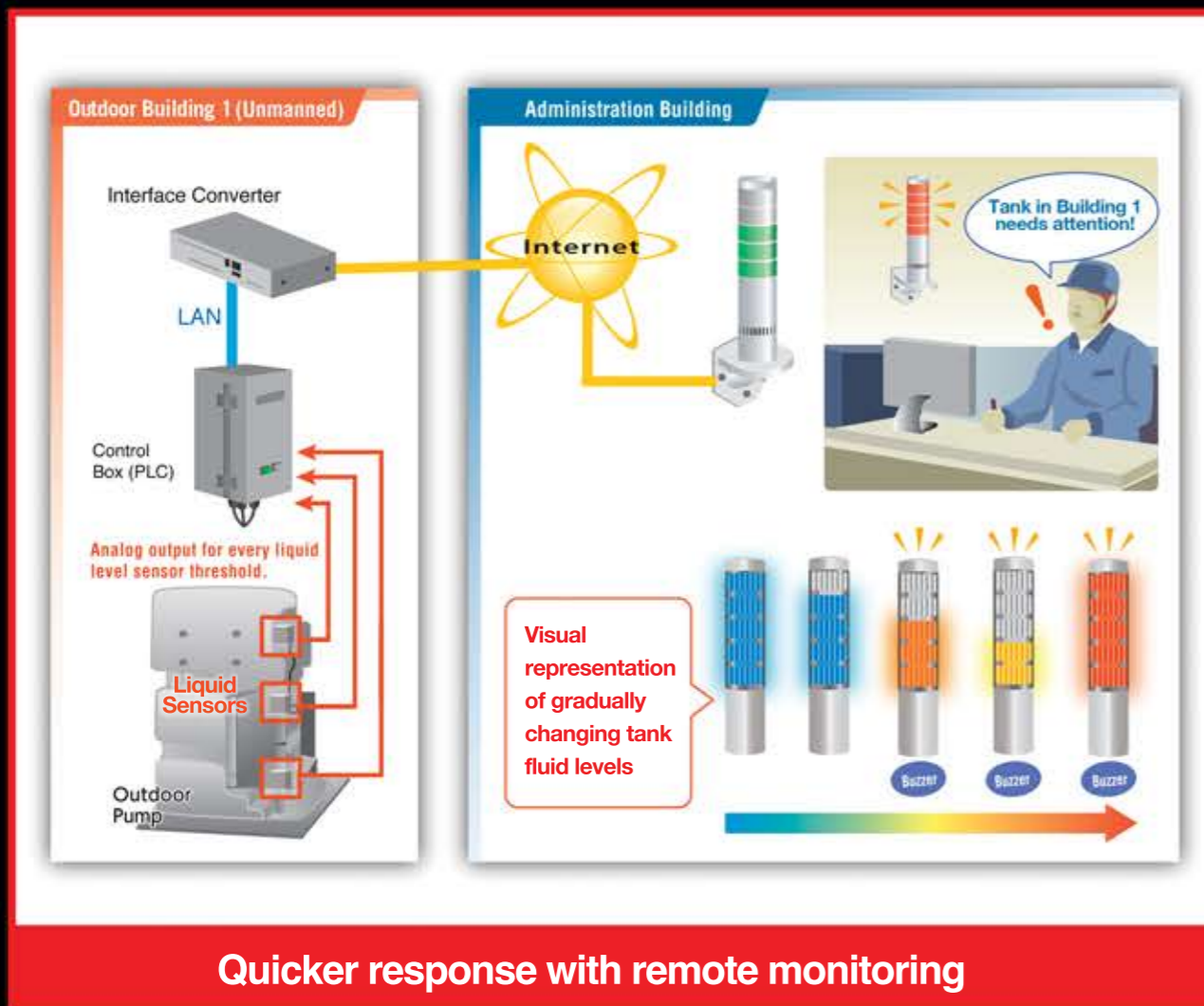

# LA6 SIGNAL TOWER



### Multi-function Switch for various setups

#### BUZZER SOUND SETUP

The built-in volume adjustment switch has 4 selectable settings.  
High (approx. 85dB) -> Mid (approx. 80dB) -> Low (approx. 75dB) -> Off

#### COLOR SETUP

The built-in switch also allows you to select up to 9 colors for each tier manually.



### A new lens design optimizes visibility.

The newly developed lens design efficiently diffuses LED light so that it is unmistakably visible, even from great distances

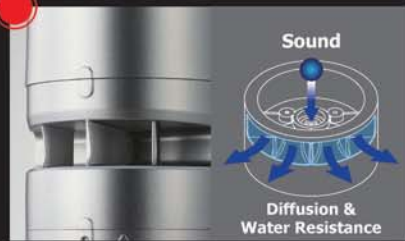

### 11 selectable alarm sounds to match various applications

A newly developed compact loudspeaker not only transmits clear sound (85dB at 1m) but is also water resistant. A different alarm sound can be set to each display pattern.



### Free editing software to freely change the LA6 colors and patterns



### Conveniently connects to an existing network with PoE support

PoE (Power over Ethernet) is a technology that lets network cables carry electrical power. PoE can bring many advantages such as reducing costs of installing electrical cabling and/or the flexibility of not having to be tethered to an electrical outlet.

### Detachable Terminal Block

Has 8 inputs for connecting PLC or discrete I/O. Data through these inputs can be transferred to a server over Ethernet. DC power can also be wired if a LAN connection is not available.



## LA6 DC24V / 3 and 5 Tier Types

## LA6 High Voltage / 5 Tier Types

The LA6 alarm feature has a total of 11 sounds to match various applications



Off White  
Flashing / Buzzer



Silver  
Lighting



Steel Pole Type (LJ)



Off White  
Flashing / Buzzer

Voltage: DC24V  
Direct Mount/Terminal (TN)  
Steel Pole with L-Bracket/Cable (LJ)

Voltage: AC 100-240V  
Direct Mount/Cable (LJ)

DC24V AC100~240V

85dB (at 1m) Buzzer 11 Sound

IP65\* Φ60 RoHS

\* Alarm Type: IP54

## LA6-POE Direct Mount / Stationery type



Direct Mount Type



Stationary Type with "Clear" switch

PoE 85dB (at 1m) Buzzer 11 Sounds Ethernet Modbus/TCP EASY WEB Setup

DC24V DC48V HTTP Inputs IP54\* Φ60 RoHS

\* Direct Mount Type

### PNS Command

By using a PNC Command, the LED unit colors for tiers 1-5 can be controlled.

### HTTP Command

Access and control all LA6-POE functions remotely in various network types with this flexible protocol.

### Modbus/TCP

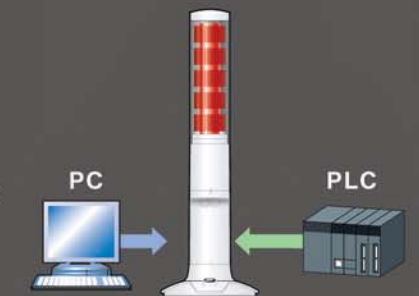

3rd Party Software LA6-POE can send machine status data over Ethernet to centralized software for remote Andon monitoring or data analysis.

## Optional Parts

For LA6/LA6-POE



Stationary Bracket Model: SZK-003W Direct Mount type

For LA6-POE



Desktop Bracket Model: SZW-060W Convert direct mount to desktop



Wall Mount Bracket Model: NH-WST2 Stationary type

Easy Setup

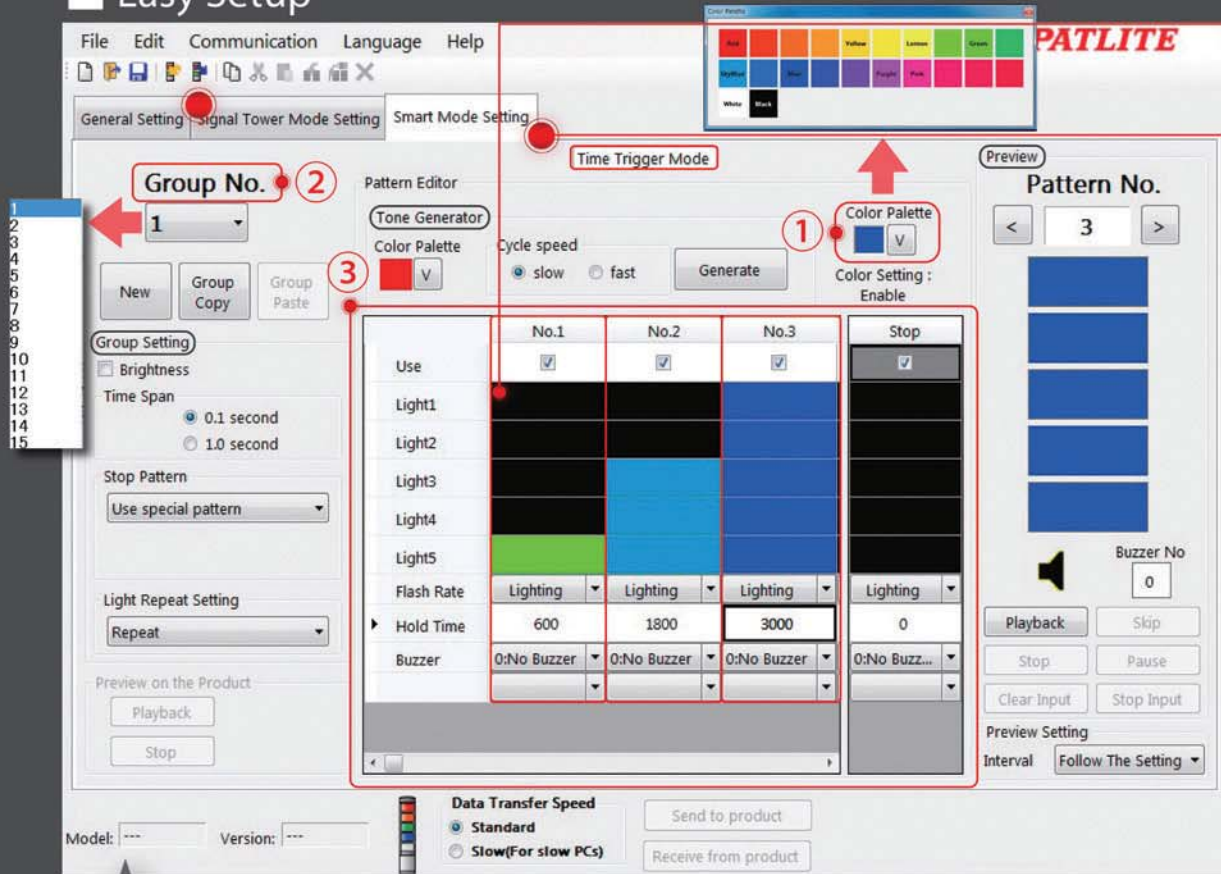

\* The screen above is only an image (conditions may vary with setup parameters).

① Color Setup (Maximum of 21)

21 different colors can be selected as part of a program

② Signal Tower Setup Features

With a maximum of 15 groups\*, 63 series of operations can be registered to perform an operation setup as one group.

\* A single display type can register a maximum of 31 groups.

③ Operations (Maximum of 63)

Select the desired color, flashing period, and the active duration of the light and alarm

● Various Setups

- Group setup (Detailed Settings)
  - Flash Reduction Setup
  - Time Span (0.1 sec./1.0 sec.)
  - Repetitive Lighting Setup
- Sign pattern generation (9 colors)  
Color select: Cycle speed (Low/High)
- Simulation  
Check the light pattern by previewing it before transmitting data into the unit.
- System Transmit and Receive  
Data can be written into the unit and also read from it, so that patterns can be easily copied into other units.

\* Data transfer is also possible when the main unit is OFF and the system's power source is the USB bus power.

<http://www.patlite.com>  
patlite Search

Editing software and pre-set data patterns are downloadable for free from our website.

Smart Mode **21 Color**

Elapsed Time / Countdown / Cycle Time

1. Time-trigger Type

Setups for individual group operation can be executed. Pattern change timing can be setup with the editing software.

Maximum pattern display	63 Patterns
Maximum group number	15 Groups

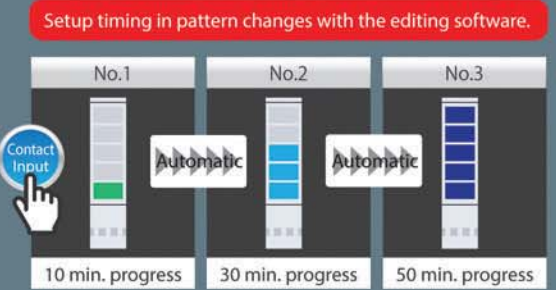

Determine thresholds for pressure/temperature, etc.

2. Pulse-trigger Type

Transitions from one pattern to another can be triggered by setting elapsed time or by individual discrete inputs.

Maximum pattern display	63 Patterns
Maximum group number	15 Groups

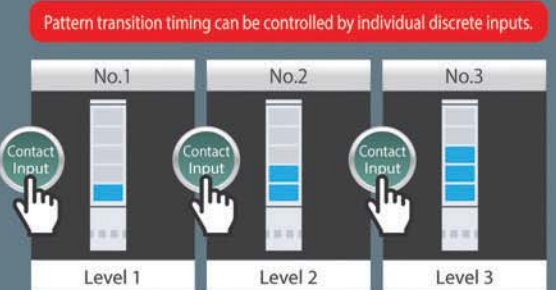

Error level/Request Priority/Status Display, etc.

3. Single-display Type

The product memory operates for "individual group" functions.

Maximum pattern display	—
Maximum group number	31 Groups

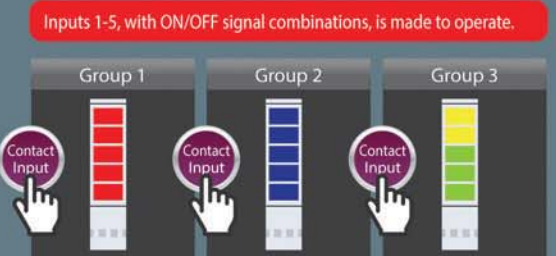

Signal Tower Mode **9 Color**

Color can be manually configured with the push button without having to edit with the software

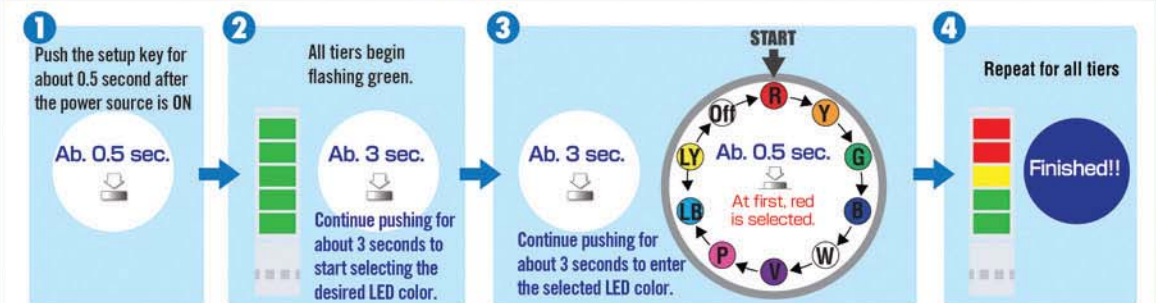

# DIMENSIONS AND WIRING

## Outer Dimensional Drawings

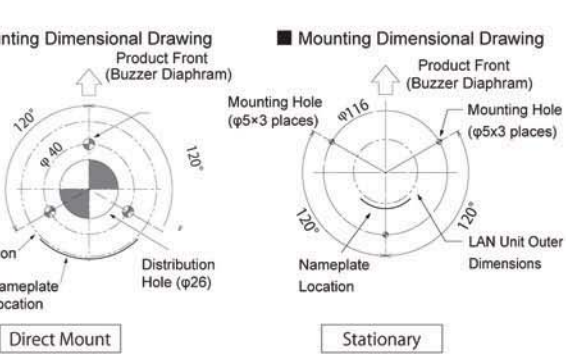
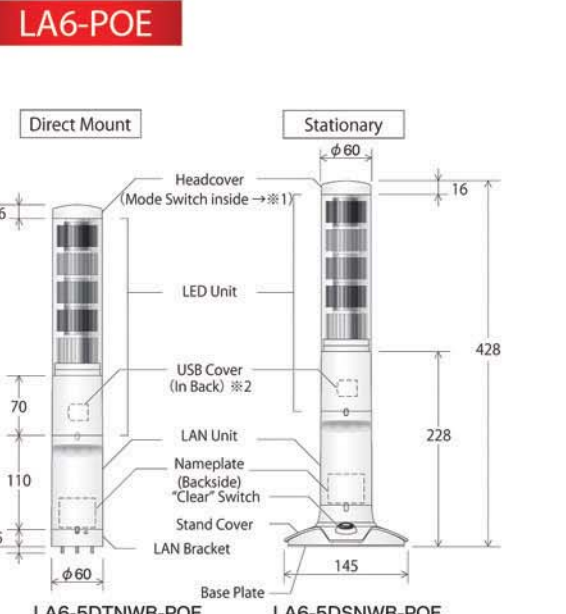
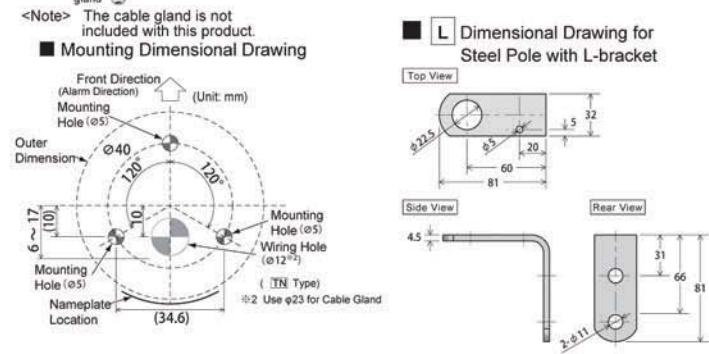
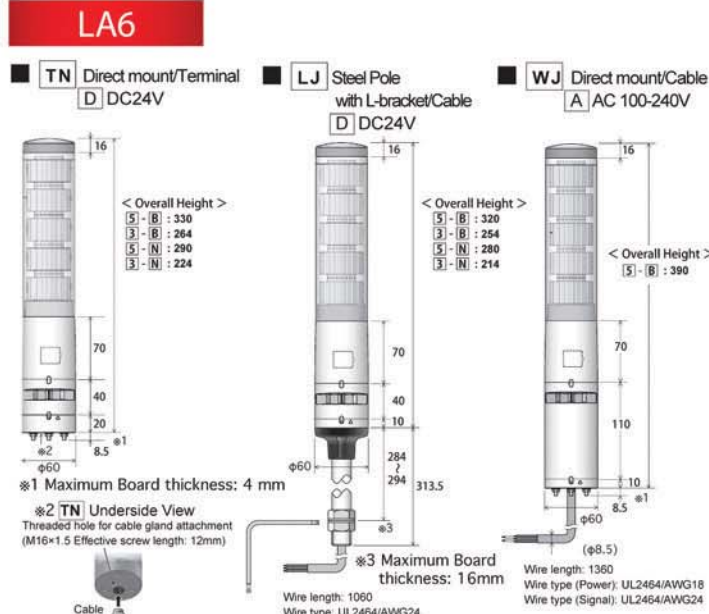

## Connector Inputs

### LA6 (Terminal Type)



### LA6-POE

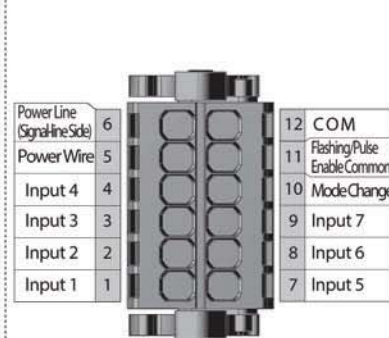

## Smart Mode Inputs (for Mode Change)

	① Time-trigger Type	② Pulse-trigger Type	③ Single-display Type
Input1 <b>Red</b>			Display Input (Binary Input Maximum 31)
Input2 <b>Amber</b>	Display Input (Binary Input Maximum 15)	Display Input (Binary Input Maximum 15)	Display Input (Binary Input Maximum 31)
Input3 <b>Green</b>			
Input4 <b>Blue</b>			
Input5 <b>White</b>	STOP	Trigger	
Input6 <b>Purple</b>	Mute	Mute	Mute
Input7 <b>SkyBlue</b>	Clear	Clear	Clear
Mode Change <b>Pink</b>	At Input		

**TO USE SMART MODE, APPLY A SIGNAL INPUT TO THE MODE CHANGE (PINK) WIRE.**

※ In mode switchover, mode switchover is 10 in the case of 11 purple and PoE specifications in the case of terminal bus specifications.

## Wiring

Red indicates the lead wire color (for Cable type models) ※ The lead wire color does not indicate the LED luminescence color.

### DC 24V Wiring (LA6/LA6-POE)

※ Be sure to check the wiring diagram of the PNP type transistor by visiting our website and viewing the comprehensive operation manual, etc.

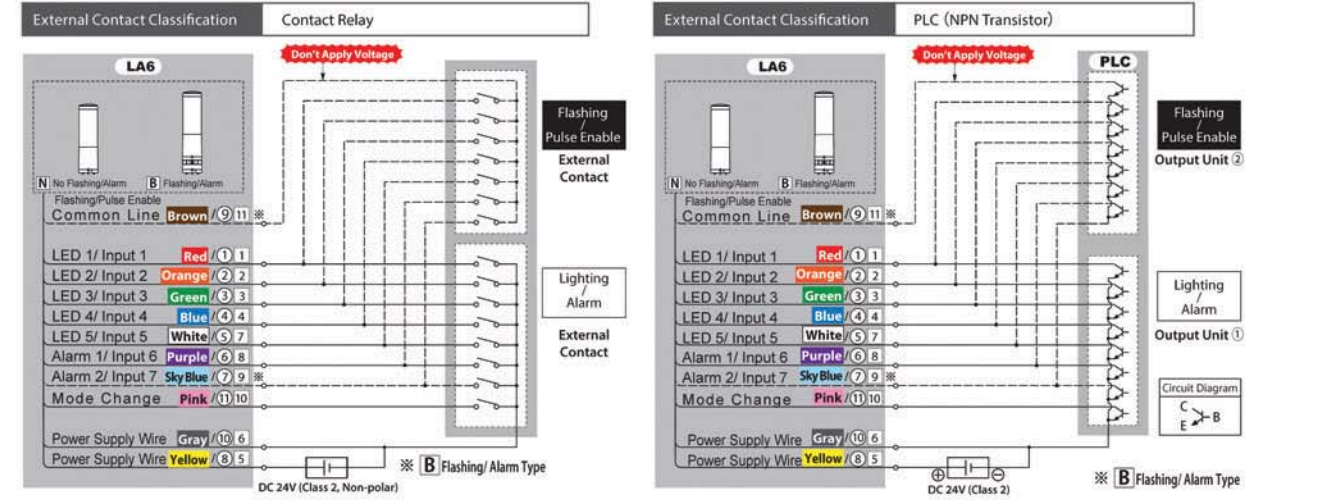

### AC 100 - 240V Wiring (LA6)

※ Be sure to visit our website and viewing the comprehensive operation manual, etc. for further details.

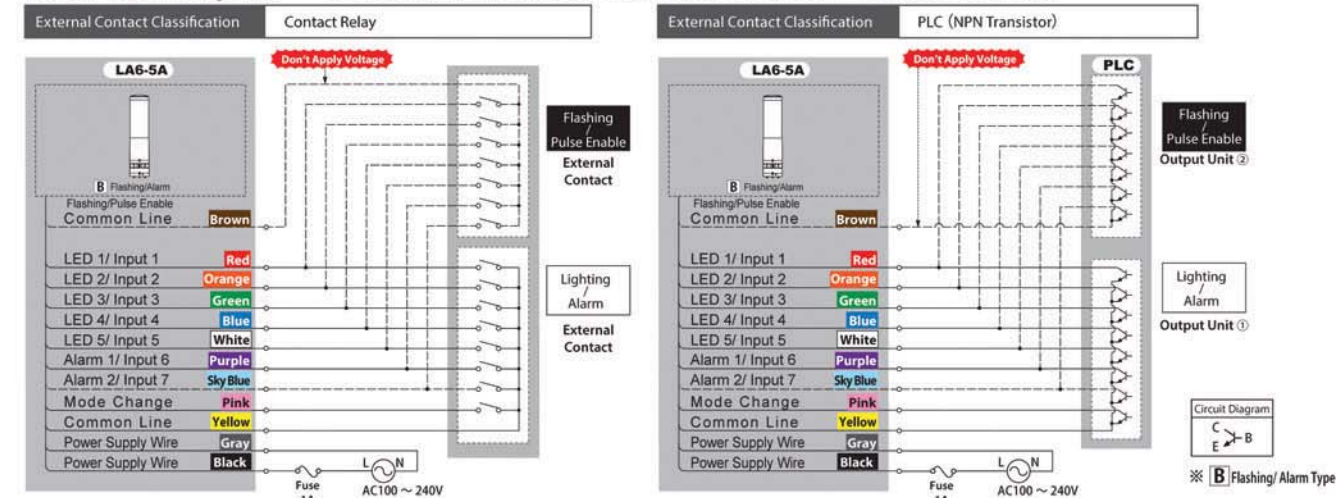

### POE Wiring (LA6-POE)

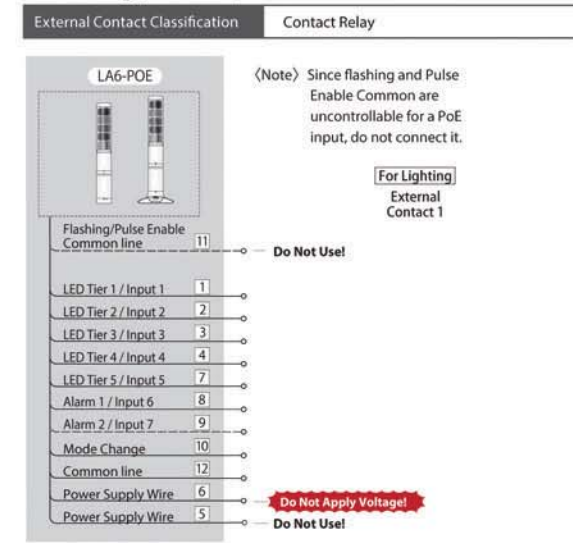

### Wiring Diagram color and number indication

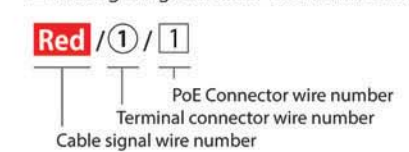

### LAN Cable Connection

The LAN cable should be rated for category 5e or higher. A straight or cross cable can be used.

- MEMO**
- Be sure to use the IEEE802.3af compliant products for the PoE power feeder systems.
  - Priority is given to the DC24V power supply when both the DC24V power source and PoE power feeder systems are connected simultaneously.
  - If both power sources are simultaneously connected, when disconnecting the DC24V source, this product may reboot.